



**United States
Department of
Agriculture**

National
Agricultural
Statistics
Service

Agricultural
Statistics
Board

Washington
D.C. 20250

March 2024



2024 Wheat Objective Yield Survey

Interviewer's Manual

Chapter 1 – Wheat Objective Yield Survey	101
General	101
Purpose	101
Farmer Benefit	102
Wheat Objective Yield Developed	103
Reports from Wheat Objective Yield Surveys	103
Use of Reports Issued by USDA	104
The Sample.....	104
How Rows and Paces Are Determined for Wheat Objective Yield.....	104
Objective Yield Equipment	105
List of OY Equipment and Supplies	105
Wheat Frame	106
Quality Control and Supervision	106
Pesticide Safety	107
Common Symptoms of Pesticide Poisoning	108
Field Re-entry Schedule Following Chemical Applications	108
Sample Field Kits	109
Sample Kit Forms.....	109
Sample Field Kit Envelope	110
Guidelines for Completing the Questionnaire	111
Locating the Sample Operators	111
Producer Letter Example.....	112
Turning in Completed Forms and Wheat Samples	113
Monthly Program.....	113
May 1 Survey	113
June 1 Survey	114
July 1 Survey.....	114
August 1 Survey.....	114
Post-Harvest Gleanings Survey.....	114
Form A-1 Timetable.....	115
Form B Timetable.....	115
– NOTES –	116
 Chapter 2 – Terms and Definitions	 201
COMMON OY SURVEY TERMS	201
– NOTES –	202
 Chapter 3 – Form A-1 Interview	 301
General	301
All States:	302
FORM A-1	303
Draw the Wheat field on a Grid Map.....	304
Sample Number and Direction.....	305
Required entries in Table A, Columns 2-5	306
 Chapter 4 – Unit Location	 401
General	401
Location, Layout and Markings	401
Laying Out Clip Areas and Locating Unit 2.....	408
Broadcast Procedures.....	409

Table of Contents

Special Problems	410
Drilled Rows Cannot Be Distinguished	410
Bounce Back	411
Unit 1 is Ripe or Hard Dough Stage on First Visit	411
Blank Areas	411
Turning Drilled Rows	412
Sample Falls in Field with Curved Corners	412
Spiral Seeded Field	413
Part of Unit Falls Outside of Field	414
Farmer Harvested Sample Field before First Survey Period	414
Odd-Shaped Fields - Starting Corners	415
Center Pivot Fields	416
Chapter 5 – Form B	501
General	501
Identification	501
Preharvest Visits	501
Pesticide Safety	502
Special Problems	502
Unit Location Information	503
Row Space Measurement	504
Measuring Distance across Row Spaces	505
Maturity Stage Coding	505
Maturity Code 1 - Pre-Flag	506
Maturity Code 2 - Flag or Early Boot	506
ITEM 6: STAGE OF MATURITY	507
Maturity Code 3 - Late Boot or Flower (Heads Emerged), Includes Watery Kernels	507
Maturity Code 4 - Milk	508
Maturity Code 5 - Soft Dough	508
Maturity Code 6 - Hard Dough	508
Maturity Code 7 - Ripe	508
Maturity Code 8 - Blank	508
Count of Stalks and Heads within Count Areas	509
Counting Stalks (or Stems) of Young Wheat	510
Clipping Instructions	513
Clipping Immature Samples	514
Bagging Instructions	515
Clipping Area ID Tags	516
Harvesting Mature Samples	517
Clipping and Mowing	518
Bagging Instructions	519
Final Preharvest or Postharvest ID Tags	520
Harvesting for Swathed Wheat Fields	521
During Survey Period	521
Between Survey Periods	522
Form B	523
Shipping to the Objective Yield National Lab	525
Good Shipping Procedures:	525
Shipping Samples in the Tyvek Envelopes:	525
Shipping Options	526

UPS 2nd Day Air or UPS Next Day Air Option.....	526
USPS Option.....	526
Packaging and Shipping Wheat Samples Dos and Don'ts:.....	527
– NOTES –	528
Chapter 6 – Form E	601
General.....	601
Location, Layout and Markings	601
Laying Out the Gleaning Unit	604
Form E Completion	605
Item 4a: All Unthreshed Whole Heads.....	605
Item 4b: All Partly Threshed Heads	605
Item 4c: All Loose Wheat Grains	605
– NOTES –	608
Chapter 7 – CAPI Data Entry	701
General.....	701
Survey Designer CAPI Editing System.....	701
Examples of Edits in CAPI Form B:	701
CAPI Form A Status Codes.....	702
Wheat Form A Status Code Definitions:	702
CAPI Form B Status Codes.....	704
Wheat Form B Status Code Definitions:	704
CAPI Response Coding and Where to Enter Comments	708

Chapter 1 – Wheat Objective Yield Survey

General

You are one of approximately 250 enumerators in 10 States employed to obtain information from farmers about their wheat crop. The information you obtain will be used to estimate wheat acreage and yields during the crop season.

Your importance in this work will become apparent as you read how these surveys operate. Briefly, your job consists of interviewing designated farm operators and making monthly observations in one or more of their wheat fields. The operators and fields were randomly selected from those farmers who reported wheat planted or wheat for harvest on current acreage surveys. You will interview each farmer on your list to find out how many acres of wheat are now expected for harvest. You will lay out at least two small units in the sample field and make plant counts and measurements during the growing season. At certain stages of maturity, you will clip a sample of wheat heads and send them to a laboratory. Soon after the crop has been harvested, you will return to some of the assigned sample fields to glean wheat lost in harvesting.

The terms "Objective Yield Survey" and "Objective Yield Forecast" are used frequently in this work. The term "Objective" means that the data are based upon actual counts and measurements. **Objective yield studies are scientifically designed. Field observations and measurements must be made precisely according to rigid rules given in this manual.** The accuracy of each forecast depends directly upon your performance and the performance of all other enumerators working on this survey.

All enumerators will attend a training school before the survey work starts. Procedures, definitions and forms will be explained. Your supervisor will give you a sample list and a field kit envelope for each sample. He/she will also give you information on the location of sample fields and instructions telling when work is to be done.

Purpose

The purpose of the Wheat Objective Yield Survey is to provide:

1. Counts and measurements which can be used to forecast or estimate yield per acre during the season.
2. Counts and weights of the wheat left in the field after harvest. These data will be used to estimate harvesting losses per acre.
3. Changes in acreage intended for harvest that result from the sample field being plowed up or destroyed after the March Agricultural Survey but before harvest.

The procedures followed on this survey provide for obtaining counts of plants growing in a specified area of the sample field. Each month the fruit on the sample plants will be counted. Mature wheat growing within the sample units will be harvested according to prescribed procedures. The various counts and measurements obtained on the monthly surveys are combined and forecasting formulas are used to predict yields per acre. Estimates of yield are obtained at harvest time when the sample units are harvested. Objective Yield Survey results have shown that the various field counts and measurements provide reliable forecasts and estimates of yield for individual States and for the Nation. The sample units are too small, however, to provide reliable yield estimates for individual fields.

2023 Wheat Objective Yield Survey Statistics

Number of States in Program	10
Estimated Samples Laid Out	1,046
Total Acreage in Sample Units	0.58
Total Harvested Acres in OY States.....	12,985,000
Percent of U.S. Acres Harvested by OY States	53%
Percent of U.S. Crop Production by OY States.....	51%

From the table above you can understand why careful, accurate fieldwork is so vital to this survey.

Farmer Benefit

The purpose of the Objective Yield Survey is to accurately predict the production of wheat at the State, Regional and National levels beginning with the May 1 forecast published in the May Crop Production report.

As you know, the size of these crops and any change in the size are crucial information needed by many people involved in and out of agriculture. This is why our reports make national news as these crops near harvest time.

The individual most needing this information is the farmer, for only with accurate statistical information about the size of these crops can the farmer make knowledgeable decisions about (1) marketing strategies (i.e. to sell early using forward contracts, to hedge on the futures market, to sell on the cash market or to use a combination of these) (2) farming practices (i.e. to alter normal farm practices such as on farm storage in place of selling or storing at the local elevator) or (3) changing intended crops usage (i.e. feeding wheat instead of selling it).

The Objective Yield Survey provides factual information which is a tool farmers can use to make knowledgeable business decisions. This tool is needed by any farmer who sells wheat.

Wheat Objective Yield Developed

Objective Yield surveys provide crop yield information for estimates or forecasts based directly on counts, measurements and weights of the crop made from small plots randomly placed in a set of sampled fields. The sample for your state was drawn from expanded acres of winter wheat for harvest in the March Agricultural Survey. Each sample has a known probability for selection based on the size of the field or operation. Objective yield surveys are completed in time to be used for monthly crop production reports.

Although crop acreage for wheat changes from year to year, some of the largest variations in wheat production are caused by fluctuations in the yield per acre. For the better part of a century, yield forecasts were based on appraisals of expected yield or conditions of the crop as a percentage of normal. This survey procedure generally produced satisfactory wheat forecasts and continues to be used.

However, large yield variations are often not fully reflected in growers' subjective appraisals. Also, sampling error cannot be measured for non-probability surveys. These problems led to the development of objective methods to forecast and estimate wheat production. The objective yield measurement program has become a vital, strengthening factor in improving monthly production forecasts and estimates throughout the crop season.

There is a continual effort to improve procedures, simplify forms, and update methods to keep the Objective Yield survey responsive to the continuing changes in the crop production activities of the nation's agricultural economy.

Reports from Wheat Objective Yield Surveys

May Crop Production	May 12, 2024
• Acreage, Yield and Production	
June Crop Production	June 9, 2024
• Acreage, Yield and Production	
July Crop Production	July 12, 2024
• Acreage, Yield and Production	
August Crop Production	August 11, 2024
• Acreage, Yield and Production	
Small Grains Annual Summary	September 29, 2024
• Acreage, Yield and Production	
Crop Production Annual Summary	January 11, 2025
• Acreage, Yield and Production	(Tentative Date)

Use of Reports Issued by USDA

Reports issued by the Department of Agriculture provide timely, accurate, and useful statistics for use by farmers, bankers, credit associations, buyers, agricultural economists, policy makers, etc. When all participants in the industry are accurately and equally informed by an unbiased source, no one has the advantage of rumors or other special information that could unfairly influence prices.

These reports may reach the farmer through commodity news service reports, Internet, television, radio, newspaper, and farm magazines. All these reports are based on NASS crop reports.

Sometimes farmers feel that USDA reports only drive prices down. It is true that prices may change based on crop reports. In the long run, however, it is the actual supply entering the market along with demand that determines prices received by farmers. Reports have had a positive effect as often as a negative effect over the years. Remember, if unbiased crop reports were not available to all parties, industry reports would be the only data available for farmers to use.

Farmers and other data users can request reports through the State Field Office. If the respondent would like a list of reports available from the State Field Office, give the operator the State Field Office address or send the operator's name and address to your Survey Statistician.

The Sample

Winter Wheat sample fields are selected from farms who reported Winter Wheat acreage for harvest during the March Agricultural Survey. All fields reported in the survey have a chance of being selected in the Objective Yield Survey. All samples are based upon recorded observations drawn so that the probability of any field being chosen is related to the size of the field. All fields reported on the survey are eligible for sampling, regardless of size. A field may be selected two or more times. If this happens, two or more sample numbers will be assigned to the field and separate counts are to be made for each sample in the field.

How Rows and Paces Are Determined for Wheat Objective Yield

There is an upper limit on the field acres which are used to determine rows and paces. For, the maximum field acres used are 128 acres. The field is assumed to be rectangular, and the width is calculated as $\frac{5}{8}$ of the length. These numbers are converted to paces and random numbers used to generate row and pace counts.

When the number of rows and paces are generated, an adjustment is made so that the unit 1 sample falls within $\frac{1}{4}$ of the field if field acres are ≤ 60 acres, and within $\frac{1}{9}$ of the field if field acres are > 60 .

These adjustments limit how many rows and paces the enumerators need to walk into the fields. The maximum number of rows for unit 1 is 409 and the maximum number of paces for unit 1 is 256. (Unit 2 is then calculated as Unit 1 + 30 more paces).

Objective Yield Equipment

The items of equipment and supplies which will be used on the Wheat Objective Yield Survey are listed below. Your supervisor is responsible for furnishing all your necessary supplies and equipment; you are responsible for the proper use and care of all items furnished. If your supplies run low or equipment becomes unusable, notify your supervisor immediately.

List of OY Equipment and Supplies

R	ITEM	R	ITEM
..	Interviewer's Manual	..	Corner Stakes
..	Identification Card	..	Unit Location Stakes
..	Motor Vehicle Accident Report Kit	..	Red Florist Stakes
..	First Aid Kit	..	Blue Florist Stakes
..	County Maps	..	Flagging Ribbon
..	State Highway Map	..	Rubber Bands
..	Canvas Satchel	..	Paper Bags (small, medium, large)
..	Clipboard	..	Scissors or Shears
..	3-Ring Notebook	..	Tyvek Envelopes
..	Sample Field Kit Envelopes	..	Sample ID Tags
..	Hand Counter	..	Shipping Labels or Address Tags
..	Yardstick	..	Kraft Envelope-9-1/2" x 12"
..	Wheat Frame	..	White Envelopes letter size
..	Ball Point Pen	..	Masking Tape

All equipment and unused supplies are to be **returned to the State Office at the end of the season** when instructed by your Survey Statistician.

Wheat Frame

The one-piece wheat frame is made of steel bar stock to measure precisely 21.6 inches inside the 4-inch tines. Avoid any misuse of the frame that might cause it to bend, changing the area to be measured.

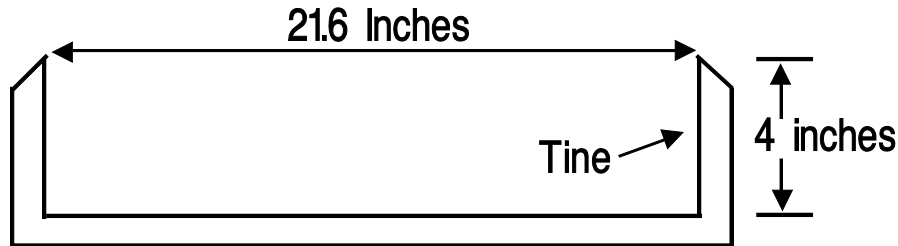

Proper use of the wheat frame is very important as are all counts made within each unit. To illustrate: The wheat frame represents 6/10,000 of an acre, and nationally there are around 1200 samples selected for winter wheat. These samples total come to about one acre of wheat, but that total one acre represents **all wheat** in the United States. As you can see, your samples and the counts you make on those samples are vitally important to the entire Objective Yield program.

Quality Control and Supervision

The Objective Yield Quality Control Program is designed to aid in the supervision of enumerators, detect faulty equipment, point out inadequacies in instructions, methods, training, and to assure that proper survey procedures are followed. A good quality control program will improve the results of the Objective Yield Survey.

The Survey Statistician is responsible for the overall objective yield program. The Survey Statistician provides most of the training at your state school and issues the necessary equipment and supplies needed for you to complete your assignments.

The Supervisory Enumerator is your immediate supervisor. Your supervisor will provide much of the "on site" field training you will need to complete your assignments. Your supervisor will also spend several hours with each enumerator during the first few days of each survey period. New enumerators will be visited first and, if necessary, revisited after they have completed samples on their own.

The Supervisory Enumerator will complete at least one (1) quality control form (Q-1) for each enumerator under his/her supervision during the survey for each crop assigned. Upon receipt of the Form B's in the State Field Office the Survey Statistician will inform the Supervisory Enumerator of the samples selected for quality control (samples worked with the supervisor will be excluded). Whenever possible, the supervisor and the enumerator should return to the sample field together while the supervisor completes the Q-1 check of the enumerator counts. The supervisor and enumerator must discuss any differences in counts and the reasons for these differences. These differences will be resolved with the enumerator and documented on the Q-1 form.

Pesticide Safety

A comprehensive pesticide safety program has been developed for all employees who may be exposed to pesticides while working on the Wheat Objective Yield Survey. The program is designed to protect you from the possibility of overexposure to harmful pesticides.

Overexposure to pesticides, particularly insecticides, could result from home, garden, and farm use, as well as unrestricted work in objective yield fields. Objective yield survey work, however, will pose little or no danger to your health when the safety precautions listed in these instructions are followed. Consult your copy of the EPA booklet, "Protect Yourself from Pesticides - Guide for Agricultural Workers", for additional information.

The safety program provides for monitoring and restricting exposure to organophosphorus insecticides. These insecticides are highly toxic to humans within several hours after application. The toxicity drops over time, but the rate of decline depends on the product used, application rate, weather factors and other variables.

Organophosphorus insecticides have been in common use for several years. Organophosphorus insecticides are used on most crops. Extreme caution must be taken to avoid overexposure to these insecticides.

To provide maximum protection for your health, the pesticide safety program requires that you take the following precautionary measures.

You will ask if any pesticide with organophosphorus content has been applied in the past month. If yes, you will obtain the name of the pesticide and the latest application date. You should explain to the operator that you work in many fields on many different farms during a short period of time and that the sole purpose of the question is to ensure that you will not be unnecessarily exposed to harmful insecticides. Informative notes, such as: "The operator will not apply a pesticide;" "He will apply some later;" The name of the pesticide applied and the last application date; should be entered on the kit envelope for future reference.

Be sure and ask the operator where the information on pesticide spraying will be posted, so you can check it every month before you enter the sample field. Enter the location on the kit envelope.

A list of organophosphorus insecticides is provided on the next page. The list includes the common names of recommended insecticides along with trade names. If a trade name is not listed, you should determine the common name of the insecticide from the farm operator, insecticide dealer or County Extension Service. If an insecticide does not appear on the list, the insecticide dealer or your County Extension Service should be able to tell you if it is an organophosphorus insecticide.

The signs of pesticide poisoning may resemble fatigue or other common symptoms of illness. However, you can protect yourself by knowing and being alert to the early warning signs of poisoning.

Look for any of these signs of sickness, but do not diagnose yourself – **GO TO YOUR DOCTOR.**

Common Symptoms of Pesticide Poisoning

- Headaches
- Dizzy spells
- Nervousness
- Sudden weakness
- Sick stomach
- Cramps
- Vomiting
- Diarrhea
- Heavy sweating
- Breathing difficulty
- Seizures
- Coma
- Pupils of the eye reduced in size

Field Re-entry Schedule Following Chemical Applications

Chemical Type:	Any Chemical	Organophosphorus Chemical	
Timing of Application:	Previous 24 hours	Previous 72 hours	Previous 30 days
Entry Restrictions:	Do Not Enter Field	Do Not Enter Field ¹	Follow Safety Requirements ²

¹Field re-entry is permitted after 72 hours.

²Prior to entering fields treated with an organophosphorus chemical application within the last 30 days, you must:

- a) Wear a long sleeve shirt, long trousers and head covering.
- b) Not wear any clothing more than one day without laundering.
- c) Limit work time to a maximum of 6 hours per day in these fields.
- d) Thoroughly wash all exposed skin (hands, face, etc.) that may have come into contact with plant foliage during the field visit.

Organophosphorus Chemicals Commonly Used in Wheat Production

<u>Trade Name(s)</u>	<u>Common Name</u>
Bracket, Orthene.....	Acephate
Sniper	Azinphos-methyl
Eraser, Govern, Lorsban, Nufos, Pilot, Warhawk, Whirlwind	Chlorpyrifos
Cobalt Advanced	Chlorpyrifos plus gamma-cyhalothrin
Stallion	Chlorpyrifos plus zeta-cypermethrin
Cygon, Cymate, De-Fend, Digon, Dimate, Dimethoate	Dimethoate
Disyston.....	Disulfoton
Ethyl parathion.....	Ethyl parathion
Atrapa, Fyfanon, Malathion	Malathion
Declare, Methyl parathion, Penncap-M	Methyl parathion
Thimet.....	Phorate

Sample Field Kits

You will have a sample field kit for each sample field assigned to you. This will be a large envelope containing the survey forms you will need for the interview and for making counts and observations on the sample(s) for each field. Make certain that you receive a sample field kit for each sample field assigned to you and that all the necessary forms are present.

The number and kind of forms in the sample field kit envelope will vary according to the month that the sample is to be laid out as shown on the following pages. The necessary identification has been entered on these forms in the State office. If there is more than one sample number in the field, this information will be shown on the face of the kit envelope and there will be additional sets of forms as needed for each additional sample. Make certain that you receive a sample field kit for each sample field assigned to you.

When you make your first visit to each field, draw a sketch on the face of the kit envelope showing the sample field, starting corner and unit location. Your supervisory enumerator or any other enumerator with the aid of the envelope should be able to return to the sample field and locate the unit with little difficulty in future months. Indicate highway or farm road numbers and approximate mileage to the sample field on the sample field kit envelope.

At the time of the initial interview, determine the date the operator expects to harvest the field. If harvest is too far away to determine at the time, check with the operator on a later visit to determine the date harvest is expected. Enter this date on your kit envelope. This will help you in scheduling your final pre-harvest visit.

A 3-ring notebook has been included in the supplies you received at the State training school. All sample field kit envelopes should be kept in the notebook. This will allow easy reference and will reduce the risk of lost forms. It may be well to arrange the sample field kit envelopes in the same order the sample fields will be visited each month.

Sometimes there are more samples selected in one of the farmer's fields. When this occurs, there will be one sample kit for each sample. Unless specifically instructed otherwise, the maximum number of samples to be laid out in any one field is four.

Sample Kit Forms

OY Form	Number of Forms Needed
Form A-1	1
Form B	4 - TX, OK, KS 3 - Other States
Form E ¹	1

¹ Only for sample numbers evenly divisible by 4 (i.e. 4, 8, 12, etc.)

Sample Field Kit Envelope

<p>UNITED STATES DEPARTMENT OF AGRICULTURE NATIONAL AGRICULTURAL STATISTICS SERVICE Washington, D. C. 20250</p> <p style="text-align: center;">Official Business</p> <p>STATE _____ Crop _____</p> <p>Variety _____ **Sample Field**</p> <p>County _____</p> <p>Segment No. _____ Tract and Field Code _____</p> <p>Lives in Segment? () YES () NO</p> <p>LSF POID _____</p> <p>Operator's Name _____</p> <p>Address _____</p> <p>Phone () _____</p> <p>Expected Harvest Date _____</p> <p>Sample Field Pesticide Use Name _____</p> <p>Schedule _____</p> <p>NOTES: _____</p> <p>_____</p> <p>_____</p>	<p style="text-align: center;">**SAMPLE UNIT LOCATION**</p> <table border="1" style="width: 100%; border-collapse: collapse;"> <tr> <td style="padding: 2px;">Sample No. _____ To be laid out _____ (Month)</td> <td style="padding: 2px;">Unit 1</td> <td style="padding: 2px;">Unit 2</td> </tr> <tr> <td style="padding: 2px;">Rows/Paces along edge</td> <td style="padding: 2px;"></td> <td style="padding: 2px;"></td> </tr> <tr> <td style="padding: 2px;">Paces into field</td> <td style="padding: 2px;"></td> <td style="padding: 2px;"></td> </tr> </table> <table border="1" style="width: 100%; border-collapse: collapse;"> <tr> <td style="padding: 2px;">Sample No. 1/ _____ To be laid out _____ (Month)</td> <td style="padding: 2px;">Unit 1</td> <td style="padding: 2px;">Unit 2</td> </tr> <tr> <td style="padding: 2px;">Rows/Paces along edge</td> <td style="padding: 2px;"></td> <td style="padding: 2px;"></td> </tr> <tr> <td style="padding: 2px;">Paces into field</td> <td style="padding: 2px;"></td> <td style="padding: 2px;"></td> </tr> </table> <table border="1" style="width: 100%; border-collapse: collapse;"> <tr> <td style="padding: 2px;">Sample No. 1/ _____ To be laid out _____ (Month)</td> <td style="padding: 2px;">Unit 1</td> <td style="padding: 2px;">Unit 2</td> </tr> <tr> <td style="padding: 2px;">Rows/Paces along edge</td> <td style="padding: 2px;"></td> <td style="padding: 2px;"></td> </tr> <tr> <td style="padding: 2px;">Paces into field</td> <td style="padding: 2px;"></td> <td style="padding: 2px;"></td> </tr> </table> <table border="1" style="width: 100%; border-collapse: collapse;"> <tr> <td style="padding: 2px;">Sample No. 1/ _____ To be laid out _____ (Month)</td> <td style="padding: 2px;">Unit 1</td> <td style="padding: 2px;">Unit 2</td> </tr> <tr> <td style="padding: 2px;">Rows/Paces along edge</td> <td style="padding: 2px;"></td> <td style="padding: 2px;"></td> </tr> <tr> <td style="padding: 2px;">Paces into field</td> <td style="padding: 2px;"></td> <td style="padding: 2px;"></td> </tr> </table> <p>1/ Additional sample in this sample field</p>	Sample No. _____ To be laid out _____ (Month)	Unit 1	Unit 2	Rows/Paces along edge			Paces into field			Sample No. 1/ _____ To be laid out _____ (Month)	Unit 1	Unit 2	Rows/Paces along edge			Paces into field			Sample No. 1/ _____ To be laid out _____ (Month)	Unit 1	Unit 2	Rows/Paces along edge			Paces into field			Sample No. 1/ _____ To be laid out _____ (Month)	Unit 1	Unit 2	Rows/Paces along edge			Paces into field		
Sample No. _____ To be laid out _____ (Month)	Unit 1	Unit 2																																			
Rows/Paces along edge																																					
Paces into field																																					
Sample No. 1/ _____ To be laid out _____ (Month)	Unit 1	Unit 2																																			
Rows/Paces along edge																																					
Paces into field																																					
Sample No. 1/ _____ To be laid out _____ (Month)	Unit 1	Unit 2																																			
Rows/Paces along edge																																					
Paces into field																																					
Sample No. 1/ _____ To be laid out _____ (Month)	Unit 1	Unit 2																																			
Rows/Paces along edge																																					
Paces into field																																					

FIELD SKETCH

North

Guidelines for Completing the Questionnaire

1. Entries must be legible and made in black lead pencil.
2. Put all entries in the boxes provided. Note the preprinted decimal. **Do not write in** any bold outlined **office use box** unless instructed to do so.
3. Write notes in the margins or blank spaces to clarify or explain entries.
4. Record all acreage entries to the nearest tenth acre. If whole acres are reported, enter a zero to the right of the decimal point.

Locating the Sample Operators

You will be assigned several Wheat Objective Yield samples. These samples will be concentrated in one geographic area as much as possible. For some enumerators, all samples may be located in one small community, but for others, travel into several counties may be required.

You will receive the name and address of all sample operators you are to contact. For winter wheat samples, you will have little additional information to help you locate the operator.

After locating the operator, introduce yourself and state that you are working with the National Agricultural Statistics Service (your region/state) field office. Explain that the National Agricultural Statistics Service is conducting a yield survey and that this farm has been selected for the survey. Present the Objective Yield cover letter on the following page to the operator before the interview starts.

Producer Letter Example



United States Department of Agriculture
National Agricultural Statistics Service
[Your] Field Office



[Date]

Dear Producer:

For more than 50 years, the Objective Yield Survey has played an integral part in U.S. crop production forecasts. USDA's National Agricultural Statistics Service (NASS) combines field measurements with farmer-reported survey data to publish monthly crop production estimates. Information from the Objective Yield Survey will help you and other American farmers make informed business decisions on your operations.

The Objective Yield Survey will begin in late April for wheat and late July for corn, cotton, potatoes, and soybeans. During these timeframes, a NASS representative will visit you and other selected producers to verify crop acreage reported on previous NASS surveys. This visit will take 15 to 25 minutes of your time. With your permission, we will then enter your field(s) at the end of each month during the growing season to collect plant and fruit counts and measurements. Our monthly follow-up visits, if required, will not require your time.

Thank you in advance for your support of our programs and [State] agriculture. If you have any questions or concerns, please contact me at (800) xxx-xxxx.

Sincerely,

[Director's Name]
Director, [Regional] Field Office
U.S. Department of Agriculture
National Agricultural Statistics Service

Enclosure

Mailing Address · City, State Zip
(000) 111-1111 · (000) 111-1111 FAX · www.nass.usda.gov

USDA is an equal opportunity provider and employer.

Turning in Completed Forms and Wheat Samples

You will be working from your home, but in close contact with a supervisor. It is important that you review your work for each sample before entering the information into the computer. Be sure that all required data are entered and that you make notes fully explaining problems and all unusual situations. Always submit the information from the forms and samples **the same day** the work is done.

Only send the paper **Form A and B** directly to the State office if requested.

When you ship samples of wheat to the National Laboratory, verify that each sample is properly identified with a **completed** sample identification tag attached to the **outside** of the paper bag. When you ship the post-harvest sample (Gleaning) to the National Laboratory, send the completed E-form within the same Tyvek.

Monthly Program

Survey Date	Work Begins	Forms to be completed
May 1	April 24	A-1 ¹ & B ²
June 1	May 25	A-1 ³ & B ⁴
July 1	June 24	B ⁵
August 1	July 25	B ⁵
Post-harvest	Within 3 days after harvest	E ⁶

¹ TX, OK - All samples; KS - even numbered samples only

² TX, OK, KS - even numbered samples only

³ CO, MT, WA, IL, MO, NE, OH (all) KS (odd);

⁴ TX, OK, KS, IL, MO, NE, OH (all); CO, MT, WA (even)

⁵ All samples

⁶ Samples with numbers evenly divisible by 4

May 1 Survey

TX, OK, KS (even): All sample fields in TX and OK, and even numbered samples in KS will be visited at this time **for the A-1 form**. You will interview the person who operates the land in which sample fields are located and complete Form A-1 for each assigned sample. After each interview has been completed, you will lay out two units **for all even numbered samples**. Then you will make plant counts and measurements and record these observations on Form B.

June 1 Survey

1. **TX, OK, KS (odd):** The work must be completed earlier in any fields that are to be harvested before the survey work week. You will interview any assigned farmers you were not able to contact during the May 1 Survey. For Kansas odd-numbered samples, complete the Form A-1. Complete Form B for all samples.
2. **IL, MO, NE, OH:** All sample fields assigned to you will be visited for the June 1 Survey. You will interview the person who operates the land in which sample fields are to be located and complete Form A-1 for each assigned sample. After each interview has been completed, you will lay out two units for **all samples**. Then you will make plant counts and measurements and record these observations on Form B.
3. **All Other States:** All sample fields assigned to you will be visited for the June 1 Survey. You will interview the person who operates the land in which sample fields are to be located and complete Form A-1 for each assigned sample. After each interview has been completed, you will lay out two units for **all even numbered samples**. Then you will make plant counts and measurements and record these observations on Form B.

July 1 Survey

The work must be completed earlier in June for winter wheat fields which will be harvested before the survey work week. A Form B will be completed for all samples, except those which were lost or samples from which heads were clipped within the count areas on the June 1 survey visit.

August 1 Survey

Make visits earlier in the month for fields which are expected to be harvested prior to the survey period.

Final Pre-Harvest Visit

Some States will have a number of late maturing fields which do not reach the "Hard Dough" stage in time for the samples to be harvested during the July 1 Survey. Therefore, you will make a visit during July (probably before the regular August 1 survey period) to complete a Form B for each of these samples. Your visit to the sample fields should be timed to occur when the fields are in the "Hard Dough" or "Ripe" (Code 6 or 7) maturity stages and as close to farmer harvest as possible.

It is very important that samples reach "Hard Dough" or "Ripe" stage before they are harvested.

Post-Harvest Gleanings Survey

Postharvest gleaning Form E's are to be completed for every fourth sample (sample numbers evenly divisible by 4, (4, 8, 12, etc.) Keep in touch with the farmer so you will know a day or so before harvesting is completed in the sample field designated for postharvest observation. You should glean the sample units' immediately after harvest so that they are not disturbed by birds and rodents or destroyed by postharvest tillage.

If there are not enough Form E's remain eligible after the initial interviews (because of a large number of screen-outs or refusals), additional gleaning samples will be selected from the remaining sample fields. You will be notified of this by your NASDA supervisor and additional Form E's will be sent to you.

Form A-1 Timetable

States should account for Form A-1 based on the following timetable:

States	Beginning Survey Period	Final Survey Period
OK, TX (all); KS (even #)	May	June
CO, IL, MO, MT, NE, OH, WA (All); KS (odd #)	June	July

Form B Timetable

States should account for Form B based on the following timetable:

Survey Date	States	Samples
May 1	KS, OK, TX	Even numbered samples only
June 1	CO, MT, WA	Even numbered samples only
June 1	IL, KS, MO, NE, OH, OK, TX	All samples
July 1	CO, MT, WA	All samples

– NOTES –

Chapter 2 – Terms and Definitions

Enumerators working on the Wheat Objective Yield Survey should be familiar with the definitions of the terms listed below. To gain the most benefit from training, you should review the definitions of these terms before attending the State training workshop. **Definitions for many of the terms listed below can be found on the [NASDA website](#) (from the NASDA-NASS page, Select General Enumerator Training, then NASS [Terms and Definitions](#) Document),** except for the ones footnoted below.

COMMON OY SURVEY TERMS

Field

List Sample

Lost Sample

Objective Yield Sample¹

Operator

POID

Sample Field

Segment

Starting Corner²

Unit³

¹ **Objective Yield Sample** - Consists of two units which are always identified as Unit 1 and Unit 2. Each sample is identified by a unique number.

² **Starting Corner** - The point of entry into the field. The first corner of the field reached when approaching the field is used for the first sample number. If the field has more than one sample, the second closest corner, following this principle, will be used as the starting point for the second sample number. The third closest will be used for the third sample, etc.

³ **Unit** – Area within the sample field to make plant counts and measurements.

– NOTES –

Chapter 3 – Form A-1 Interview

General

The purpose of Form A-1 is to update the acreage of Wheat expected to be harvested since the March Ag Survey. These forms will also determine the sample field for the Objective Yield sample, determine acreage to be excluded when locating the sample units, obtain permission to locate sample and gleanings units in the field, and obtain information on whether or not the field is intended to be irrigated.

The Form A-1 used to require a face-to-face interview. The Form A-1 has been updated so NASDA enumerators can complete the initial interview over the phone.

Attempt Form A-1 by phone for all Wheat samples before attempting any Face-to-Face contact.

The different forms used for this survey are printed on paper of different color for easier identification. You will notice that some spaces on the form have bold outlined boxes. These bold outlined boxes are for office use only and enumerators will not make entries in these spaces unless they are instructed to do so. Use only erasable pencils to complete all objective yield forms. Do not change, erase, or mark out any entries made by the State office. Before you begin an interview, review all forms so you know beforehand precisely what questions to ask the operator.

To avoid asking the operator duplicate questions during the initial interview, you only need to ask the questions on the second page of Form A-1 (Items 1 and 2 and Table A) once for each operation.

These questions provide the necessary initial interview data regardless of how many samples are located on the farm or sample field. Shortly after the interview is over, copy these data from the first form onto the additional Form A-1's for all samples in this operation.

When you start to work on a sample, be sure the label indicating State, operator identification number, sample number and direction indicator is on each form. If not, copy this information from the sample field kit envelope. Enter the date that you make the phone call for the interview.

Your first contact with the operator is very important. Review the discussion of interviewing techniques in your [NASDA Employees Handbook](#).

Introduce yourself and tell the operator that you are representing the National Agricultural Statistics Service (State Field Office) of the U.S. Department of Agriculture. Explain that the National Agricultural Statistics Service is conducting a Wheat yield survey and that this operation has been randomly selected for the study. The purpose of this survey (see Chapter 1) is to estimate crop yields based on counts and measurements from small sample plots in selected fields, and the operator's cooperation will be most helpful. Some of the operators you will contact had fields in the Objective Yield Survey in past years, so this will not be new to them.

On the front of Form A-1, there is a statement which briefly introduces the survey. Use a conversational tone when making the statement and answer any questions the operator may have. The operator may wish to accompany you to see what you do in making field observations. This is fine, but work steadily,

practice social distancing, and do not take too much of the farmer's time.

If the farm operator is not available when you call, arrange to call back. If the farm operator is not expected back during the survey period, you may obtain the required information from another informed person. In the event no informed person can be found to give the information during the survey period, contact your supervisor. **Do not enter Wheat fields without permission.**

If not completed at the time of the first survey period, Form A-1 and Form B should be completed during the next survey period. However, you should try to complete these forms during the assigned survey period.

All States:

For Form A-1, interviews with operators selected from the March Agricultural Survey, you will **not** have an aerial photo. The acreages on this form pertain to the grower's entire operation. The State office will have entered acres of Wheat intended for harvest on the entire farm reported earlier, but no data for fields are available prior to your phone call or visit.

For Form A-1 interviews, all acreage recorded on the Form A-1 must be recorded to the nearest tenth of an acre. For Example:

Reported	Entered	
25	25.0	
25.25	25.3	(When rounding a 5, always round up)
25.12	25.1	
25.75	25.8	(When rounding a 5, always round up)
25.68	25.7	
None	(-)	

FORM A-1

All States:

You will use Form A-1 for the initial interview of all Wheat growers selected. Items 1 and 2 pertain to Wheat acreage for harvest on the entire farm. Table A pertains to all the sampled fields for this operation. Items 3-9 pertain to the sample field.

The name and address of the selected operation you are to contact has been entered on the field kit envelope and Form A-1. It is very important that you verify this information. Any changes in name and address such as spelling, box or route number, ZIP code, etc., should be corrected on the field kit envelope and on the Form A-1.

If the operation is known by a farm, ranch, or business name, this should also be noted. Listed below are examples of common corrections which should be made:

Mayes	Hayes , Arthur Rt. 1 Red Oakes, YS 46725	Cody, John Rt. 1, Box 608 Pinetown , YS 54670 Bear Poplar, YS 54690
	Sanders, Tom and Rob Bob No. 2 Cove Road Jamesville, YS 46652	Flying J. Ranch MGR Merle King Bob Gray Rt. 1 Box 608 Edenton, YS 46647
SOLD	Twin Ranch Ridgeview Farms, Inc. MGR Tony Mills Evergreen, YS 46104	Paul Gum R.R. 5 Elkin, YS 46520 Farm name - Hill High Ranch Farm

The operator may have changed the acreage of Wheat to be harvested since intentions were reported during the March Agricultural Survey. In that case, Item 2 will differ from Item 1. Never change Item 1 but write notes so that the office staff understands the situation.

Example 1: The operator does not currently operate the entire acreage reported as Wheat in March. For example, part or all the land was sold, leased, or rented to someone else.

Procedures:

1. Include the land that has changed hands in with the original operator's acreage.
2. Select the sample field(s) based on the total acres and fields as reported in March. If the sample field(s) is controlled by the original operator, obtain permission to enter the field. If the sample field is now operated by a different person, you will need to contact this new operator for permission.

- Obtain the name, address, and phone number of the new operator regardless of whether you need to make contact on this survey.

Example 2: The operator currently operates more land than reported in March.
The additional land, bought or leased, may have Wheat planted on it already.

Procedures:

- Exclude this new acreage.
- Select the sample field(s) based on fields operated in March and proceed with interview.

Example 3: The operator still operates the land reported in March and has not acquired additional acreage. The difference between Item 1 and Item 2 is due to:

- A respondent or enumerator error on the March Agricultural survey
- The actual planted acres or harvest intentions changed from the intentions reported in March.

Procedures:

- Select the sample field(s) based on the actual acreage of the operator, corrected for the issues mentioned above.

1. Earlier this season, the number of winter wheat acres you intended to harvest on all the land you operate was.....	ACRES	
2. What are the total acres of winter wheat for harvest on the land you operate? (If total equals zero, end interview).....	ACRES	102

The next statement will serve as an introduction to Table A.

Now, I need to identify one (or more) of your winter wheat field(s) and get their acreage.

Notes:

- Complete Table A for the winter wheat fields based off the cardinal directions indicated in column 1 below.

Complete one row in the table for each sample selected. Start with the first sample, then complete the rest of the samples in ascending order (from lowest sample number to largest sample number).

Draw the Wheat field on a Grid Map

The purpose of the grid is to help locate the Wheat sample. You will want to start by locating the homestead in the grid. The home location should be in the middle of the grid. Have the operator describe any roads, landmarks, and natural boundaries that will help you identify and keep track of the fields. Use the grid to sketch the roads, landmarks, etc... Use of a county highway map in conjunction with the grid map may also help you as you and the operator identify the sampled field. Scale is not important; however, the relative location is critical.

If you have problems drawing the grid map because the farms fields are spread out over many counties,

call your Survey Statistician for instructions.

Sample Number and Direction

The samples are labeled with a letter that represents a cardinal direction:

N = North
NE = North-East
E = East
SE = South-East
S = South
SW = South-West
W = West
NW = North-West

And either a:

C = Closest field in selected direction to the farm operation
F = Furthest field in selected direction from the farm operation

If a sample is marked with the letter “N” for North and “C” for Closest, have the operator identify the northern most field that is closest to the farm operation in the State. If two fields are the same distance north, select the field on the right (clockwise).

Select one Field per sample until there are no more fields.

A majority of operations will only have one sample. For more guidance on operations with more than one sample, please discuss with your Regional Field Office for more information.

Required entries in Table A, Columns 2-5

For each sample, record the data required in Table A:

1. Total Acres in Field (Column 2): Record all acreage in the field. Be sure to match the sample number assigned on the grid to the sample number in Table A.
2. Acres in Other Uses: Columns 3 and 4 are used to indicate any areas in the field from which Wheat will not be harvested.
3. LOCATION DESCRIPTION/INTERSECTION OF FIELD (Column 5): Record landmarks, features, and street or road intersections to help identify where the field is located.

The direction variable will determine in which field the sample will be laid out. One sample is selected for one field. There will only be one sample per field listed in Table A, unless there are fewer fields in the operation than the number of samples selected for the operation. After selecting the sample field, you will complete the interview by asking Items 3-8 for each sample field using Form A-1.

TABLE A

SAMPLE Number and Direction	TOTAL ACRES IN FIELD	Acres in USE or CROPS OTHER THAN WINTER WHEAT to be HARVESTED for GRAIN or SEED <i>(For example: not seeded, bare spots, winter kill, waterways, roads, other crops, etc.)</i>		LOCATION DESCRIPTION/ INTERSECTION OF FIELD <i>(E.g., landmarks, features, street intersections)</i>
		USE	ACRES	
1	2	3	4	5
21 NC	25.0	Not Seeded	3.0	N near bridge and river
22WF	35.0	Not Seeded	1.0	East of Farmstead
23SF	105.0	Flooded out	1.0	South of Farmstead

Chapter 4 – Unit Location

General

Two units are laid out for each sample at the time of the initial interview. These units will be used each month during the growing season to make plant and fruit counts. The units are located and laid out according to specific procedures to assure randomness. First locate the selected sample field using the grid map and County and State maps.

For winter wheat samples, immediately after completing the Form A-1 interview and before going to the sample field, determine the paces to be used for locating the units. To do this, find the appropriate field size on the labels on the back of your field kit envelope. The acres of winter wheat for harvest in Item 3, Form A-1 determines which column is to be used. Circle the unit location numbers under the appropriate field size on the labels. The rows line corresponds to the paces along the edge of the field and the paces line corresponds to the paces into the field. Copy these unit location numbers to all Form B's and the Form E for the sample.

For subsequent sample locations, use the next set of unused labels. Circle the numbers as they are used. There is one set of labels for every sample selected for an operation. Unit locations have been entered by the State office for all winter wheat samples.

Record the date in the space provided at the top of the Form B.

Location, Layout and Markings

The principle of unit location is to allow the units to fall anywhere within the field boundaries (excluding deducted acreage from Form A-1) with equal probability. See examples in Special Problems (Chapter 5). Therefore, the point of entry into the field will be the first corner of the field reached when approaching the field. If the field has more than one sample, the second (third, etc.) closest corner following this principle will be used as the starting point for the second (third, etc.) sample number. The steps outlined below and the illustrations in this section should be followed in complete detail when locating, laying out and marking sample units.

Step 1: Mark the starting corner so it will be clearly visible on later visits. Tie a piece of plastic flagging ribbon to the fence or some nearby object or drive a tall stake in the ground and attach the ribbon. Make a note of the location and type of marking used on the kit envelope field sketch.

Step 2: Start your count of paces one and one-half feet outside the plowed edge of the field. You should walk parallel to the longer side of the field for the number of paces shown on the Form B under Unit I opposite "Number of paces along edge of field." When you reach the last pace shown on the Form B, tie a piece of flagging ribbon to the fence or nearby object for easy location on later visits.

Step 3: Turn at a right angle, pick out a point of aim and walk **into** the field the required number of paces. Start your count of paces one and one-half feet outside the plowed edge of the field.

Important: If you cross any of the areas deducted in the "other uses" Column 4 of Table A, Form A-1 while you are counting your paces into the field, stop counting the paces at the start of each such area and resume counting at the other side. Any blank or unplanted areas in the field that are not deducted on the Form A-1 should be included in the pace count.

Step 4: After you have taken the last of the required paces, place a yardstick so that it touches the toe of your shoe and crosses the three drill rows just beyond your toe or to the left of your toe, depending on the direction of the rows at that point. If no drill rows can be distinguished, see Broadcast Procedures Chapter 5, and the illustration for Step 4.

Example:

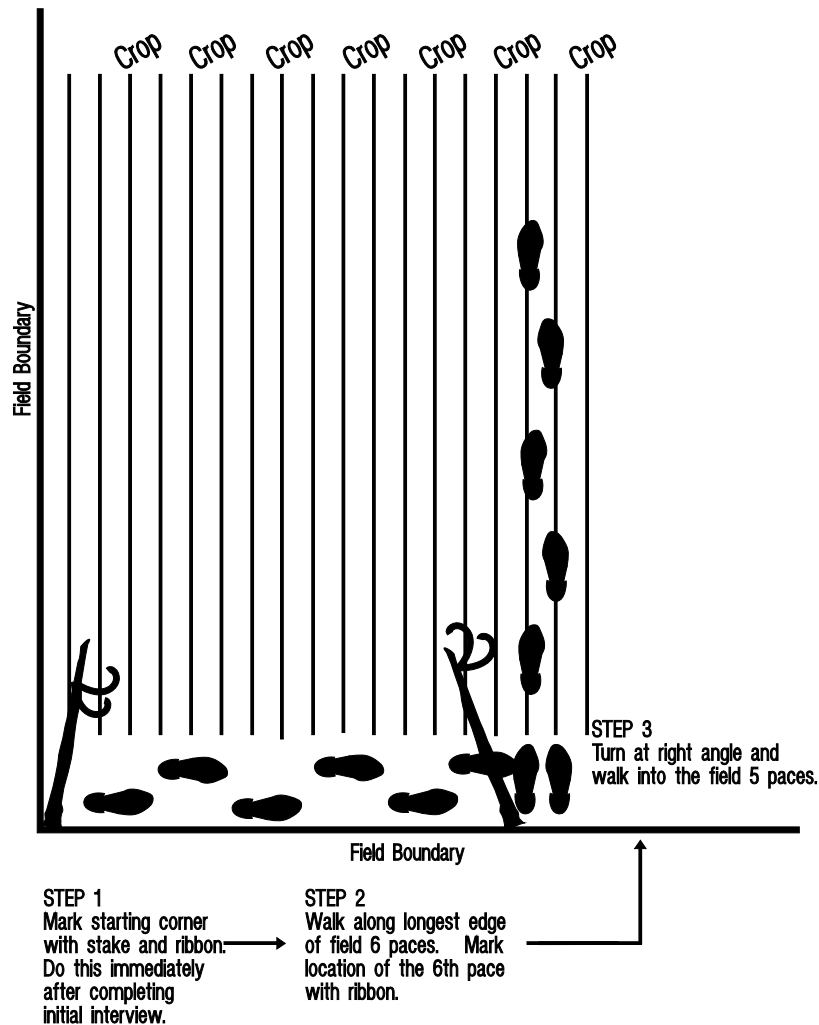

Walking with Crop Rows

Or

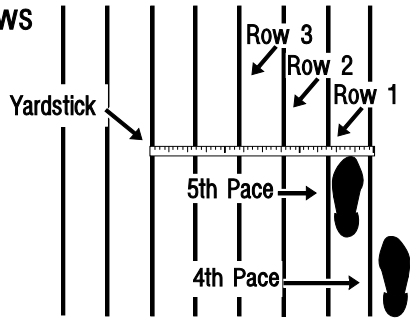

STEP 4
Lay Yardstick down
at the end of toe
crossing 3 drill rows
to your left.



Walking Across Rows

Or

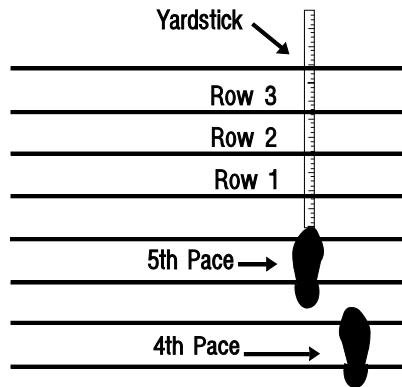

STEP 4
Lay Yardstick down
at the end of toe
crossing 3 drill rows
beyond toe.



No Distinguishable Rows
(Broadcast)

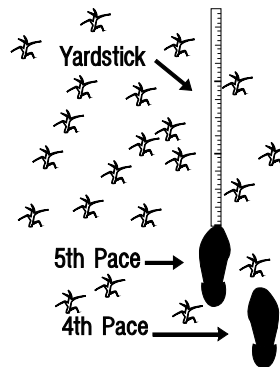

STEP 4
Lay Yardstick down
at the end of toe.
(See Broadcast
Procedures)



Step 5: Lay out 5 foot buffer zone. The buffer zone is always laid out to the **right** of the yardstick. Anchor the zero end of the 50 ft. steel tape just beyond the yardstick and directly alongside the plants in Row 1.

The zero end of the tape must be anchored firmly and close to the ground so it will not move when the measurement is being made. Mark the sample number (e.g., S-11) on a red florist stake (anchor stake) and insert it at this anchor point.

Step 6: In Row 1 place a red starting florist stake, marked "U1-R1" exactly 5 feet from the anchor point. The florist stake should be placed in the row at the base of the plants. This marks the buffer zone.

Step 7: Reposition the yardstick within the 5-foot buffer so that it touches the starting florist stake and crosses three drill rows. Be careful to position the yardstick in a straight line from the starting florist stake across the 3 drill rows.

Step 8: The wheat frame identifies the length of row included in the unit. Always place the frame to the right of the yardstick. Working from outside the unit, carefully slip the wheat frame into Row 1 through the base of the plants with the inside corner of the left tine touching the florist stake just placed in Row 1. The tine(s) of the frame may divide a plant that has many stalks ("ribs of an umbrella"). You are to slip the frame through the base of the plants immediately to the right of the yard stick (with the starting stake touching the inside corner of the left tine); thereby, allowing the tine (short arm) to determine which stalks are included or excluded for the unit. Do not move stalks in or out of the frame. Mark the first row with a red florist stake, then lift the frame over the first row and push it up to the second row and mark it. Repeat this again to mark the third row. Always mark the rows one at a time being careful to lift the frame before moving it up to the next row. The 2 tines should extend through the row with the back of the frame parallel to the row. Be sure that the inside corner of the tines are touching the florist stakes.

When the unit falls in a blank area (no wheat): 1) lay out the count area but do not lay out clip areas and 2) revisit the unit the following survey period to verify it is still blank (no wheat).

Important: Always place the frame to the right of the yardstick, even though the count and clip areas may be laid out towards the starting corner. Indicate on the kit envelope the direction of the unit and position of the lightweight stake (4-foot stake).

Example:

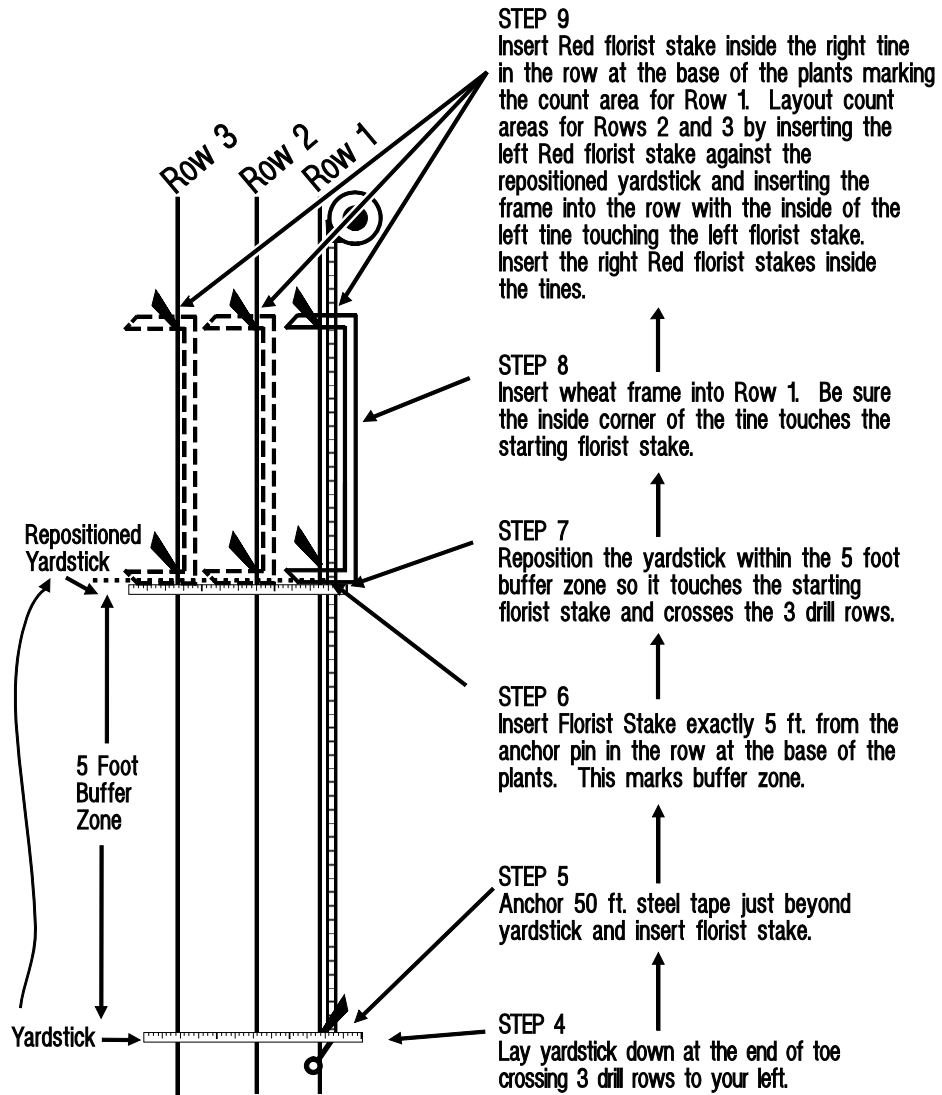

Step 9: Mark the lengths of the three rows in the unit with red florist stakes by inserting a stake into the ground at each point where the inside edge of the frame tines cross the row. This will require six red florist stakes (the starting florist stake, already placed plus 5 more). The three red florist stakes marking the left side of the count area should be identified by unit and row, i.e., U-1, R-1 or U-1, R-2. This will aid in identification, if on a later visit some stakes are missing. After you have carefully marked the count area of Sample Unit 1 with six red florist stakes, remove the frame from the third row. Care should be taken not to step into or otherwise disturb the area to the immediate right of the count area. Two clipping areas (discussed in Step 10) will be laid out in this area. If the field is not in the hard dough or ripe stage (maturity code 6 or 7) at the time you lay out the unit, mark the general location of the unit with a lightweight stake about 4 or 5 feet long. This will help you spot the unit from a distance when the wheat is taller. This stake should be placed four rows away from the left hand corner of the unit so that strong winds will not blow the mature wheat in the unit against the stake and shatter the heads. Also, position the stake in the pathway of your next visit. This will help prevent anyone from walking into the unit and accidentally damaging the plants in future visits.

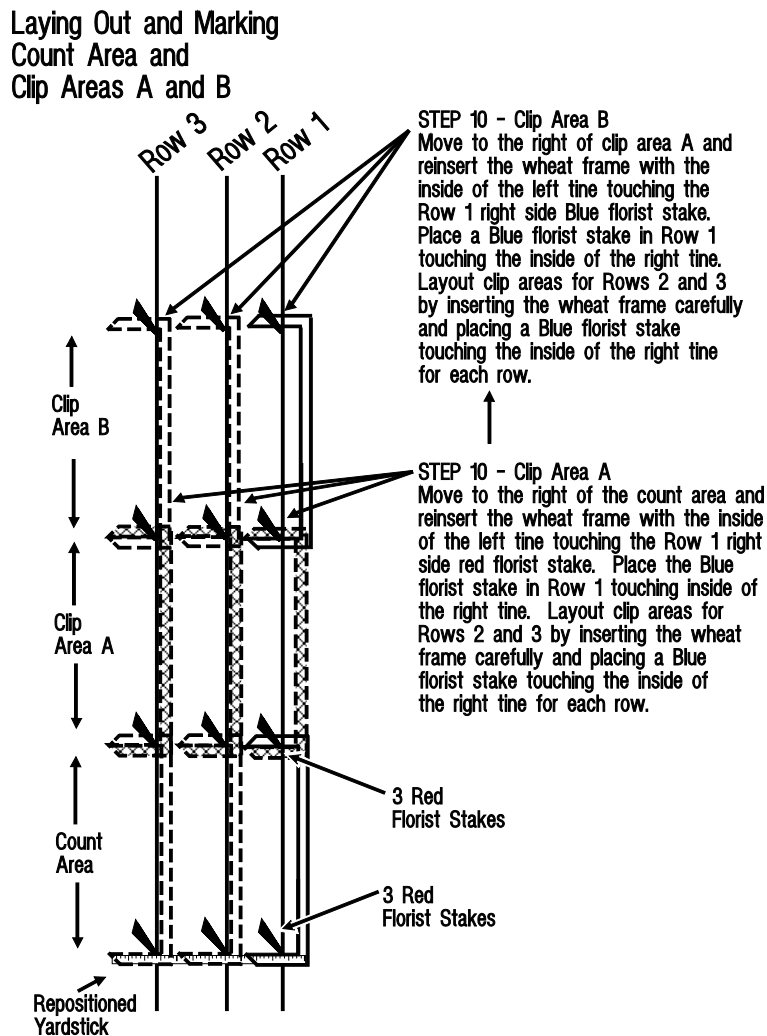

Step 10: Laying out and marking Clip Areas A and B.

Important: Clip Areas are required when the Unit 1 count area is in Pre-flag through Soft Dough Stage (Maturity Codes 1-5). Clip areas are not required when the Unit 1 count area is in Hard Dough or Ripe Stage (Maturity Code 6 or 7).

Clip Area A: Move to the right of the count area and reinsert the frame with the left tine just inside the count area and immediately adjacent to the Row 1 right-hand red stake. Place a blue florist stake in Row 1 inside the right tine to mark Row 1 of Clip Area A. Mark all three rows being careful to lift the frame before moving into the next row.

Clip Area B: Repeat this same procedure to lay out the Clip Area B immediately to the right of the first clip area (A). When the maturity of Unit 1 is Code 3, 4, or 5, clippings will be made from a specified row in one of the "clip areas". The row to be clipped in each one of the clip areas is identified on the Form B.

When no distinguishable rows are present, refer to Broadcast Procedures Chapter 5.

Step 11: Locating Unit 2.

After completing the Form B observations in Unit 1, start from the last pace required for Unit 1 and walk 30 paces parallel with the longer side of the field and in the same direction that you were traveling when you located Unit 1. Then turn at a right angle and walk 30 more paces into the field, to locate, lay out and mark Unit 2. Remember to stop counting paces when walking through a deducted area (refer to Table A, Form A-1)

Repeat Steps 4 through 10 for Unit 2. The red florist stakes should be identified as in Unit 1, changing the unit number (U-2, R-1; U-2, R-2; etc.).

Important: While laying out the units and later while observing plants and counting and clipping heads, you should be careful to avoid rough handling and trampling of plants in the three sample rows within the count or clipping areas. Do not destroy or remove wheat plants, other crop plants, or weeds in and around the unit.

Laying Out Clip Areas and Locating Unit 2

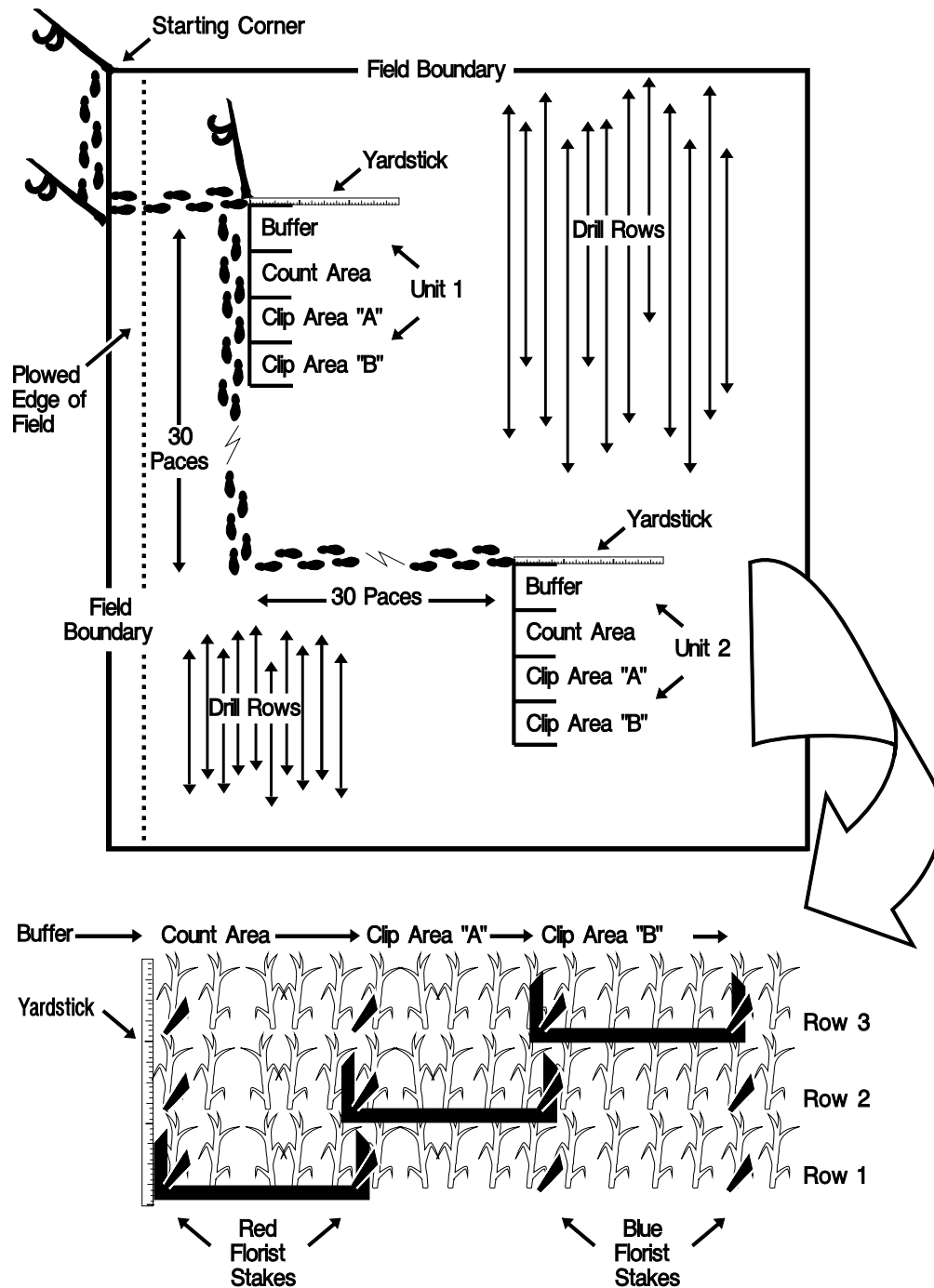

Broadcast Procedures

When no drill rows can be distinguished at your last pace into the field you will use these procedures to locate and lay out units.

This situation usually occurs because of broadcast seeding, reseeding to improve the stand or when a sample unit happens to fall in an area used as a turn row or where the farmer drilled out the corners.

After you have taken the last of the required paces, place the yardstick down pointing straight ahead and immediately in front of your toe. (See earlier illustrations). Lay out the 5-foot buffer zone to the right of the yardstick. Anchor the zero end of the 50-foot steel tape at the end of your toe touching the yardstick. Be sure the pin is firmly anchored, and the zero end of the tape is close to the ground so it will not move when the measurement is made. Mark the sample number (e.g., S-11) on a red florist stake (anchor stake) and insert it at this anchor point.

Measure to the right in a straight line perpendicular to the yardstick, exactly 5 feet. Insert a red starting florist stake, marked "U1" exactly 5 feet from the anchor point.

Reposition the yardstick within the 5-foot buffer so that it touches the starting florist stake. Be careful to position the yardstick in a straight line from the florist stake parallel to its previous position. The end of the yardstick closest to the starting florist stake (marked U1) is always the lower left-hand corner of the count area.

The wheat frame will be used to mark a square 21.6 inches on a side. Working from outside the unit carefully slip the wheat frame through the base of the plants with the inside edge of the left tine touching the (starting) florist stake at the inside corner. The wheat frame identifies the area included in the unit.

Insert the ending florist stake (red) at the inside corner of the right tine. Two corners (1st & 2nd) of the square are marked.

Pick up the frame, lay it parallel to the yardstick with the second red stake in the corner of the frame. Place a red stake in the far inside corner of the frame marking the third corner of the square. Again, pick up the frame, place it with a tine parallel to the yardstick and with the third stake in the inside corner of the frame to locate the fourth corner of the square.

You must square off the area by making sure the diagonal distance (from the third stake to the first stake) is 30.5 inches. If it isn't square, move stakes to make the area square.

Each of the four corners of the unit are marked with red florist stakes. Draw plastic flagging ribbon tightly from one corner to the next. Mark the general location of the unit with a locator stake as in Step 9.

Now mark both clipping areas using blue florist stakes and plastic flagging ribbon. Divide the clip area into 3 equal parts or thirds (7.2 inches or .6 feet) with the steel tape and mark with blue florist stakes. Attach flagging ribbon between stakes (see dotted lines). Each third will represent one row plus its associated middle. Record all row space measurements as **999.9** for broadcast seeded units.

Special Problems

Drilled Rows Cannot Be Distinguished

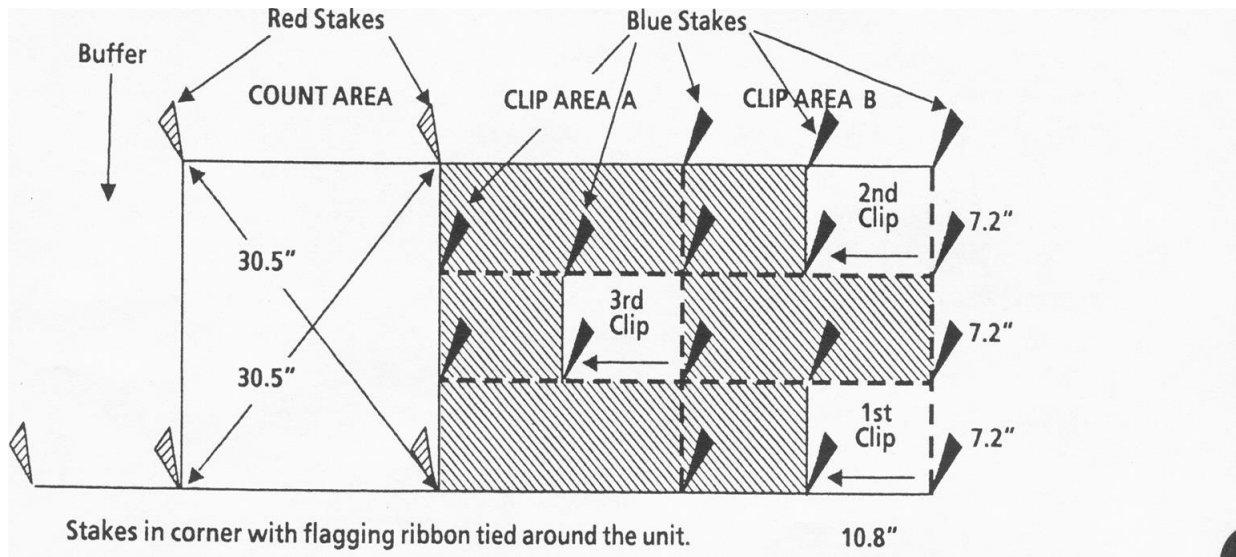

This situation usually occurs because of broadcast seeding, reseeded to improve the stand, or locating a sample unit in an area which was used as a turn row or where the farmer drilled out the corners.

Refer to Broadcast Procedures for instructions to follow.

You are to record the total number of stalks or heads in the units in the Row 3 Column, leaving Row 1 and Row 2 blank.

Bounce Back

When pacing along the edge of the field, or pacing into the field, if you reach the opposite end or side of the field and still have not taken the required number of paces, turn around and walk back in the direction from which you came until the required number of paces has been stepped off.

After the last pace, place the yardstick so that it touches the toe of your shoe and crosses the three drill rows immediately in front of your toe or to the left of your toe depending on the direction of the rows at that point. Lay out the buffer zone to the right of the yardstick regardless of its relation to the starting corner.

Unit 1 is Ripe or Hard Dough Stage on First Visit

All heads in the count units will be clipped as the final operation in completing a Form B for samples in the ripe or hard dough stage on the first visit. All stakes will be removed just before you leave the unit. The clip areas will not be laid out.

Blank Areas

Sample units will never be in excluded areas or in any other areas reported in "Other Uses" in Form A-1, Table A. However, some units may fall in legitimate blank areas, i.e., areas reported as having wheat for harvest as grain.

If only one sample unit falls in a blank area, continue to make counts on the other unit. Enter dashes in the appropriate box for the unit located in the blank area.

If both sample units fall in a blank area (no plants standing in any of the three sample rows) the count area will be laid out but no clip areas will be laid out. Dashes should be entered where appropriate for the units on the Form B which should be returned to the State office. Note on the Form B and the kit envelope that the units fell in blank areas. Revisit the units the following survey period to verify they are still blank (no wheat). If blank, no further preharvest visits will be made to the sample. A postharvest gleaning visit (using Form E) will be required if it is a gleaning sample.

Turning Drilled Rows

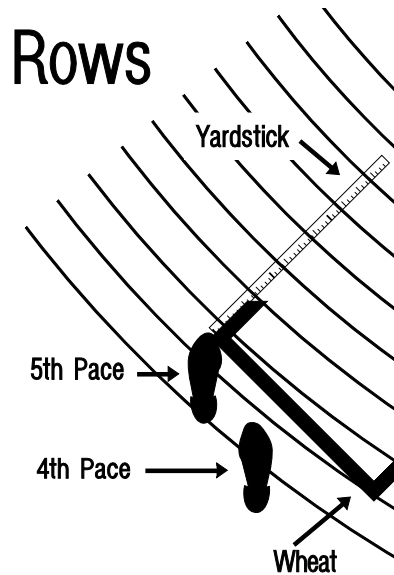

When the unit falls in turning (curved) rows such as may be found in corners of a field, you will not be able to lay the yardstick down in the usual manner. You will lay your yardstick down at the tip of your toe but angling it to be as nearly perpendicular to the rows as possible. Then lay out the unit in the usual manner.

Sample Falls in Field with Curved Corners

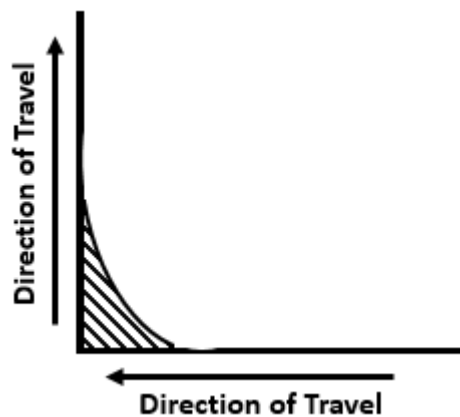

Handle the same as you would a circular field. Count down the side of the field while straight and when the corner curves, continue in a straight line to a point equal to the edge of the field. Turn towards the field at a 90-degree angle and count in that direction. If the corner of the field outside the curve was included as crop on the Form A-1, include it in your counts. If the area was excluded on the Form A-1, exclude it in your counts.

Spiral Seeded Field

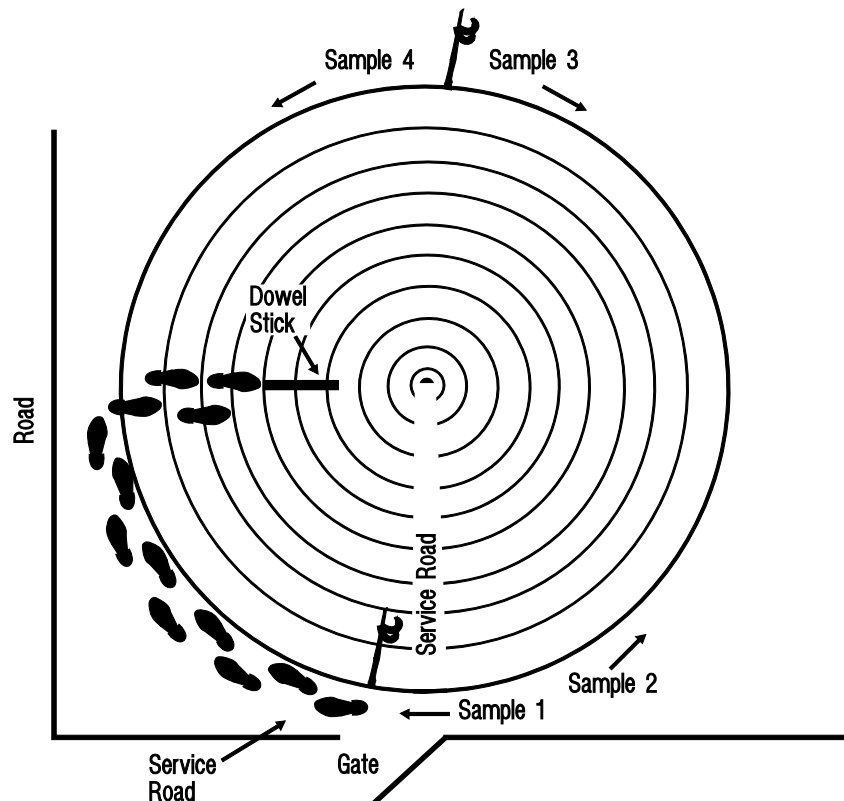

The starting point will be that point first reached when arriving at the field. To locate sample units in a spiral seeded field, use paces as shown on the Form B when walking clockwise along the edge of the field. Then use the number of paces shown on the Form B to count paces into the field. Be sure your diagram on the kit envelope is complete and is easy to follow in locating the sample units in the spiral field.

A second sample in a spiral field would be located in a counterclockwise direction from the original starting point. If a third sample was selected, go to the opposite side of the field from the original starting point and locate the third sample in the clockwise direction. If a 4th sample is required, locate it in the counterclockwise direction.

Part of Unit Falls Outside of Field

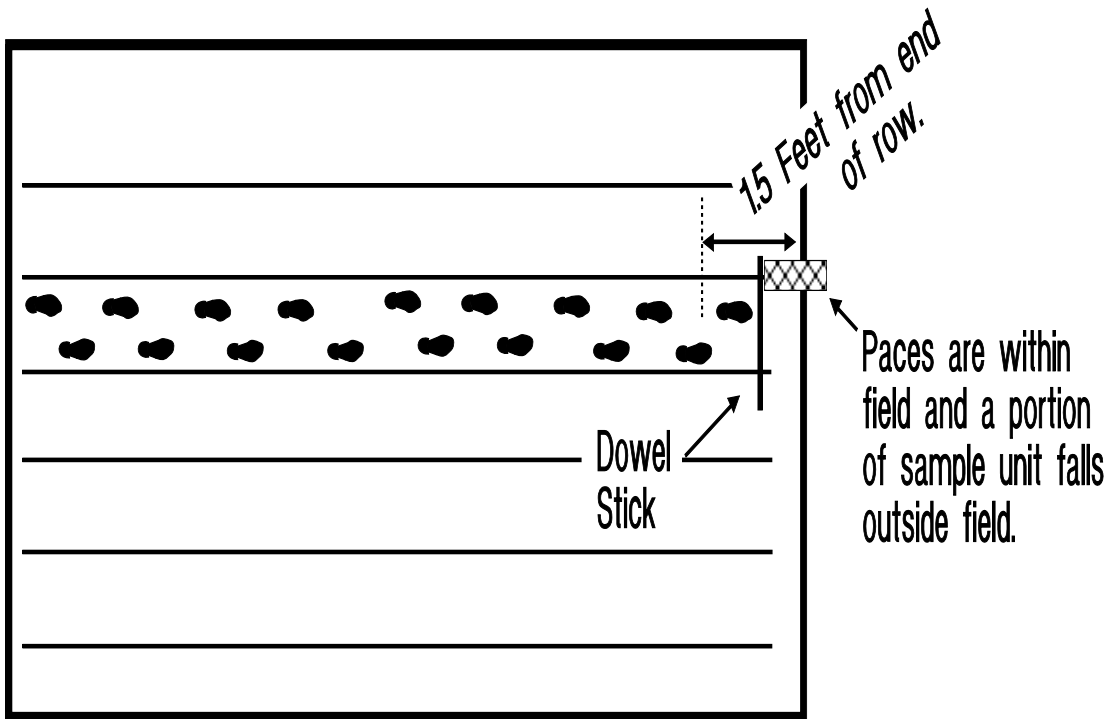

When the number of paces into the field will cause part of the unit to fall outside the field proper, decrease the pace count until the entire unit is included in the main body of the field by 1 1/2 feet.

Farmer Harvested Sample Field before First Survey Period

Conduct the initial interview (Form A-1). Return all other forms with notes explaining that farmer harvest occurred before the survey period.

Odd-Shaped Fields - Starting Corners

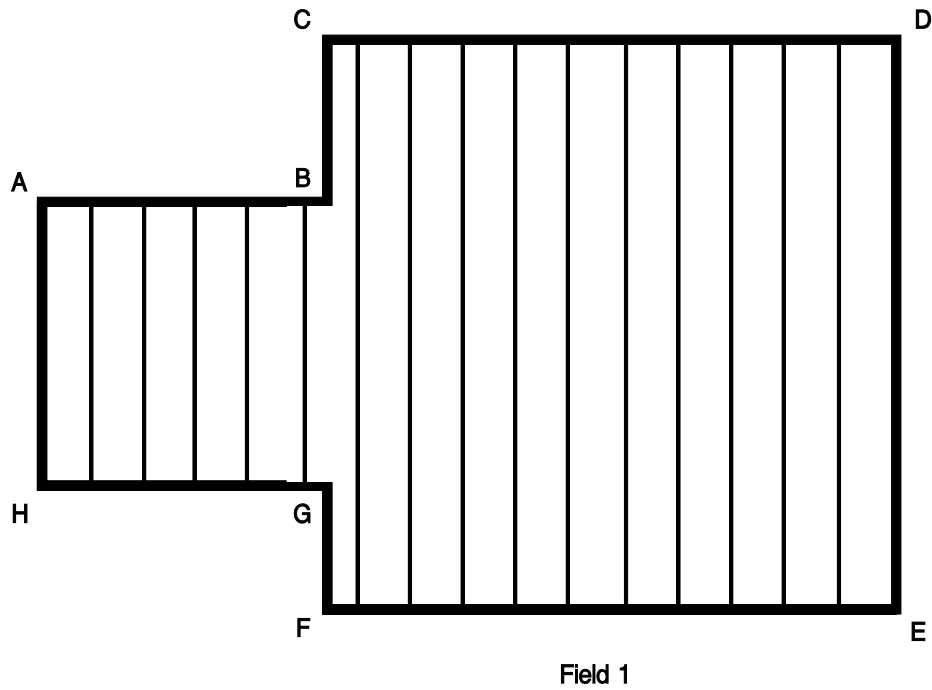

Field 1

Corners A, D, E or H could be the starting corner under the "unit location" principle because the sample unit would have equal chance of falling anywhere in the field.

Corners B, C, F or G cannot be the starting corner because the unit has less chance of falling in the areas of the field marked by the corners (A, B, G, H).

Center Pivot Fields

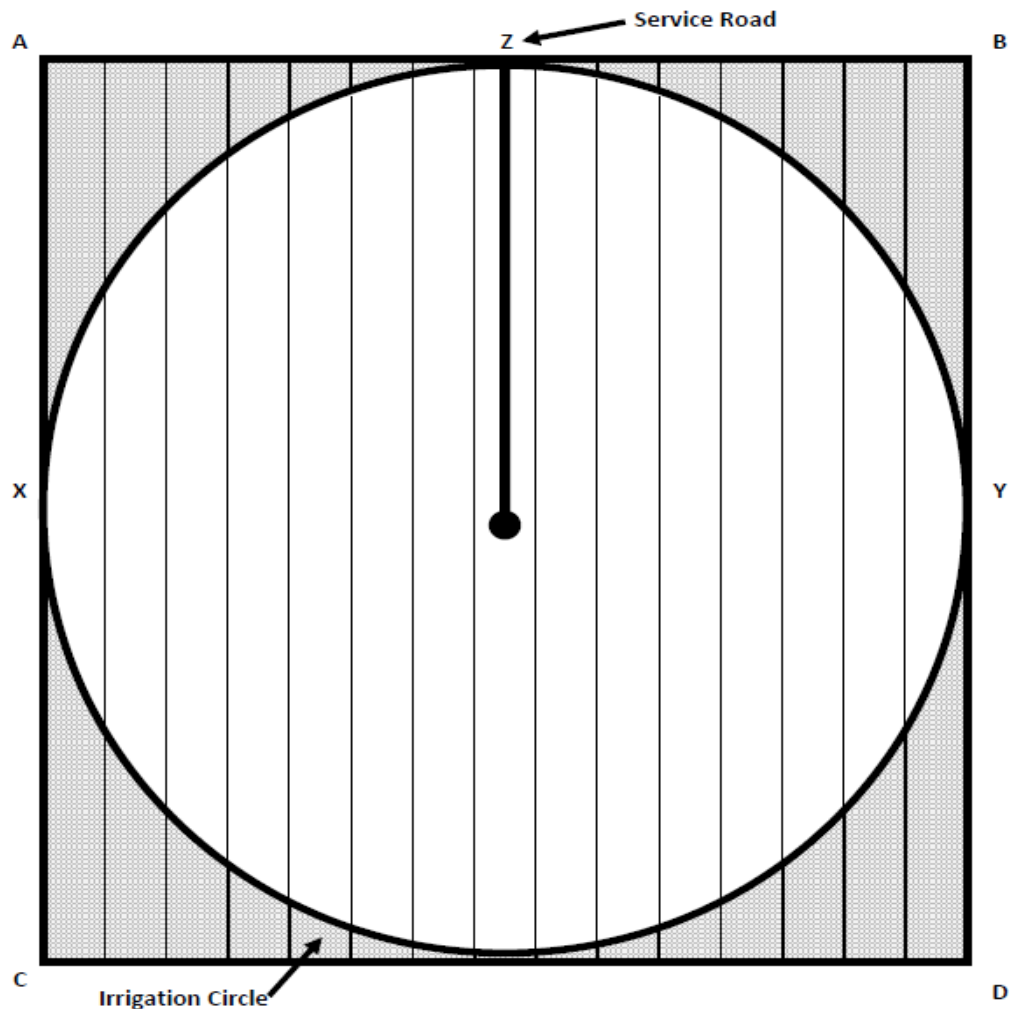

Scenario 1

The entire field including corners, is planted to wheat. Since there is no differentiation between irrigated and non-irrigated plantings for wheat in any state, the correct choices for starting corners are A, B, C, and D even though the access road is at point Z. In most cases, the most accessible starting corners will be A and B since the service road can be accessed from the same side of the field. Paces along the edge of the field and into the field will be counted in the usual manner.

Scenario 2

The circle only, not including the shaded corners, is planted to wheat. Since the service road (point Z) is the most accessible corner in most cases, which is considered the starting point. While standing at point Z, unit 1 will be laid out to the right (towards point X). After unit 1 has been laid out, go back to point Z and lay out unit 2 to the left (towards point Y). Paces will be counted in the usual manner.

Chapter 5 – Form B

General

The purpose of the Form B counts and observations is to develop an indication to help set the monthly wheat crop yield estimates. Each item counted and head clipped is a very important step in the process of setting monthly production forecasts or estimates. Only through careful adherence to the Objective Yield Survey procedures can reliable forecasts and estimates be made.

Identification

You will record unit observations using the Form B for each survey period. Be sure the identification (usually a label) is in the space provided at the top of each Form B. If it is not, you must record the identification from the sample field kit envelope.

Preharvest Visits

The regular visits you make within the survey periods before the units reach maturity stage 6 or 7 will be known as preharvest visits. During these visits, you will harvest heads from clip area A or B when the units are in maturity stage 3, 4, or 5. When the units reach maturity stage 6 or 7, this will be your final preharvest visit.

The heads inside the sample count area are to be clipped on the final preharvest visit. The clipped heads represent grain ready to be harvested by the farmer. Ideally, the sample units will be clipped the same day the field is harvested. It is crucial you do not categorize green samples (code 5 or earlier) as mature (code 6 or 7). Green samples (immature) sent to the laboratory give an inaccurate indication of yield. If you are unsure of whether the maturity category is 5 or 6 it is best to code it 5 and wait a week for further ripening.

It will be necessary to make many final preharvest visits to samples between regular survey periods. This will occur when the unit maturity stage has not yet reached Code 6 stage (Hard Dough) during the regular survey visit but will be harvested by the operator before the next monthly survey period. "Between surveys" visits must be made no more than three days prior to farmer harvest of the sampled field. Telephone the operator before making these "between surveys" visits to determine when the field will be harvested. Record this information onto the field kit envelope. You may make personal visits if you are already in the neighborhood.

Pesticide Safety

Forms A-1 and B have a question asking if the operator has applied or will apply pesticides with organophosphorus content to the sample field. If yes, the date of latest application and name of the pesticide must be recorded. If the operator doesn't know if, or when, pesticides will be applied, be sure to note this on the kit envelope and make contact again before entering the field.

You are responsible for following all precautions set forth in Chapter 1. Never enter a field when pesticide has been applied earlier in the day.

Special Problems

When returning to samples for the second, third, or fourth monthly visit, you will generally have no problem finding the sample units. However, for a few samples you may need to use one or more of the following procedures:

Example 1: Wheat is still standing in the field, but the sample unit location stake has been removed or fallen over or for any other reason you are unable to find the unit(s).

Procedure: Lay out a new sample unit(s) using the same number of paces along and into the field as shown on the Form B and also on the kit envelope for the sample unit(s). Start from the same corner of the field as when the sample unit(s) were first laid out. Code Item 4 "2" for each unit that was relocated. Measure width of 4 row spaces for unit(s) and enter in Item 5 of the Form B, if drill rows can be distinguished.

Example 2: Part of the field has been harvested including the area where one or both sample units were located.

Procedure: Record dashes in Items 7 to 9 for each unit that was harvested. Write "Unit(s) ____ Harvested" in margin of Form B. Locate gleanings for the harvested unit(s) in the harvested part of the field.

Example 3: Part of field has been destroyed by the farmer (plowed, disked, mowed, cut for hay, etc.) including the area where one or both sample units were located.

Procedure: Record dashes in Items 7 to 9 for each unit that was destroyed. Write "Unit(s) ____ Destroyed" in margin of Form B. If only one unit was destroyed, complete all items for the remaining unit as usual. Also lay out both units on the postharvest visit. When laying out the units, you would not count paces when crossing the part of the field that was destroyed.

If both units are destroyed, gleaning units should be located in the portion of the field that is harvested for grain. (See instructions in Chapter 8.)

Example 4: The entire field has been harvested for grain, cut for hay, plowed, disked, etc.

Procedure: Write "Field Harvested for grain, cut for hay, plowed, etc." on Form B. If harvest for grain has occurred within 3 days, complete the Form E gleaning. Otherwise, obtain gleaning in an alternate field. (See instructions in Chapter 6.)

Example 5: Unit 1 of the sample is in Soft Dough stage (Code 5) and the other is mature (Code 6 or 7). The operator plans to "patch" harvest the field before Unit 1 reaches maturity Code 6 or 7.

Procedure: Make the required counts and clippings for both units as prescribed for maturity Code 5. Then make the regular "National Laboratory" clippings from the count area of the mature unit. Be sure to record the Item 9b count which will be edited out by the State Field Office for the current month but used when the immature unit is ready for processing as mature (final preharvest Form B). Inform both the Survey Statistician and the National lab of the situation by writing notes on the Form B and ID tags. Return to the immature unit whenever it reaches Code 6 or 7 and obtain the count area clippings plus complete the final preharvest Form B. The counts for Items 8, 9a and 9b for the previously mature unit will be recorded from the earlier Form B by the State Field Office. Postharvest gleanings (if gleaning sample) will need to be done on separate visits as soon as possible after each unit is harvested.

Unit Location Information

UNIT LOCATION	UNIT 1		UNIT 2
2. Number of paces along edge of field	[]	+ 30	[]
3. Number of paces into field	[]	+ 30	[]

Record the date in the space provided at the top of the Form.

4. UNIT LOCATION CODE	1 First Sample Count 2 Unit relocated this month 3 Sample counted previous	Enter Code	305	307
	<i>Go to item 6 when coded 3; otherwise go to item 5.</i>			

A Unit Location Code of "1" should be coded for the first month counts are made of the units; then go to Item 5. On later visits if you are unable to locate the unit laid out earlier and it is necessary to lay out a new unit, you will Code "2" for the unit and go to Item 5. If you find the unit that was counted previously, enter code "3" for that unit and go to Item 6.

Row Space Measurement

5. ROW SPACE MEASUREMENTS

	UNIT 1	UNIT 2
a. Measure distance from stalks in Row 1 to stalks in Row 5	Feet & Tenth	Feet & Tenth
	301 . ____	303 . ____

The purpose of row space measurements is to derive plant population. Since we are measuring so few rows in the field an error will have severe effects on the yields throughout the season. You must record the distance in feet and tenths of feet. Be sure your tape measure is calibrated in feet and tenths of feet and not in feet and inches.

The measurement of row spaces will be made only on the first visit except when one or both units are relocated. This measurement will be left blank on later visits except when one or both units are relocated.

If a sample unit happens to fall in an area where no drill rows can be distinguished, you will not complete Item 5 for the unit, but you must note the reason in the margin of the Form B.

For Item 5, measure the distance across four drill row spaces at the first placement of the yardstick (beginning of the buffer zone) with the steel tape. Start at the **center** of the stalks in Row 1 and measure across four row spaces, or middles, to the **center** of the stalks in Row 5. (See illustration following this page). If there are not enough rows remaining to get a 4-row space measurement, measure from the center of the stalks in Row 2 in the direction of Row 1 across four row spaces. Occasionally, at the edge of the field, no distinguishable rows can be observed. If this happens, obtain the measurement by moving the anchor pin toward the unit until rows can be distinguished.

Attention: Make a note of unusual row spacing because of double row, skips, lapping by drill, etc.

Measuring Distance across Row Spaces

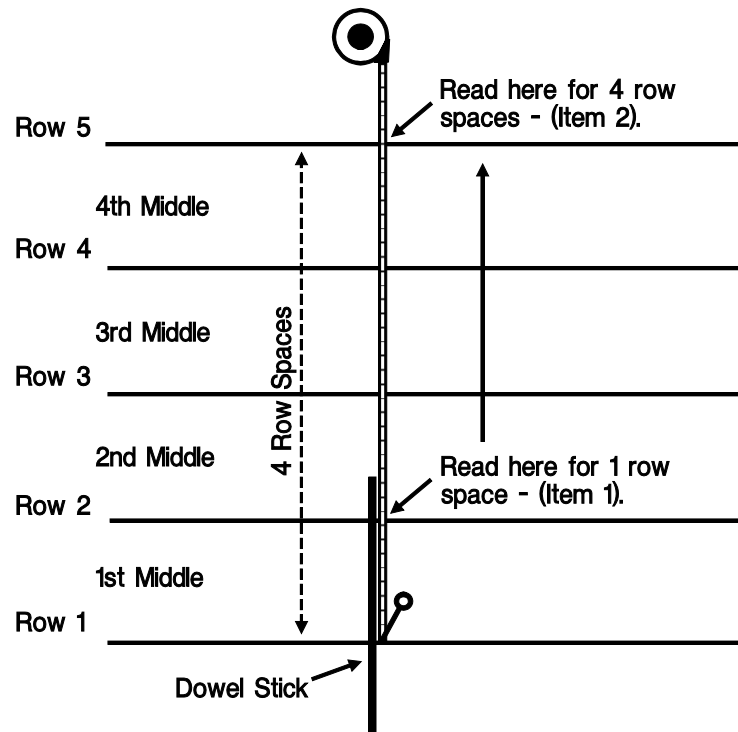

Maturity Stage Coding

6. STAGE OF MATURITY: (Circle one code for each unit)

MATURITY STAGE	PRE-FLAG	FLAG OR EARLY BOOT	LATE BOOT OR FLOWER	MILK	SOFT DOUGH	HARD DOUGH	RIPE	BLANK
Unit 1 Count Area	300 1	300 2	300 3	300 4	300 5	300 6	300 7	300 8
Unit 2 Count Area	302 1	302 2	302 3	302 4	302 5	302 6	302 7	302 8
If Unit One Maturity is:	1 or 2, start counts with Item 7.		3, 4, or 5, start counts with Item 8.			6 or 7, start counts with Item 8.		8, substitute Unit Two. When both 8, go to Item 10.

A stage of maturity is to be determined in each unit count area by circling the numerical stage code in the Item 6 table. The stage which you assign the unit will be the stage with the greatest number of stalks inside the unit count area. Do not damage any plants in the unit. When most plants in the unit count area have started to head, examine a few plants of similar development outside the unit to assist you in determining the maturity. Use the descriptive material which follows as criteria for arriving at the stages of maturity. There will be cases when you are undecided on the maturity stage of the unit. When this

occurs, review the maturity stage descriptions involved and classify the unit in the stage that it most nearly represents. If still undecided, classify it in the lower stage of maturity.

Maturity Code 1 - Pre-Flag

This is a general category in which you will record all units where tillers are only an inch or two high, up to units where stalks are large or mature enough to be in the "Flag or Early Boot" stage. The stalks do not indicate any swelling and do not have the definite flag leaf or other evidence of a partly developed head inside the leaf sheath.

Maturity Code 2 - Flag or Early Boot

Stalks are starting to joint, and joints can be seen easily. The plant has four or five leaves and the "flag leaf" is identifiable and its collar is visible above the top foliage leaf. A partly developed head may be detected by noting that the stem has started swelling below the top foliage leaf (swelling at the widest point). This swelling may also be felt inside the sheath. Be careful not to damage the partly developed head by squeezing the stem sheath.

In most cases, the presence of heads enclosed in the leaf sheath could be verified by going outside the unit. Examine stalks that are similar in appearance to the doubtful ones before classifying the unit in the Flag or Early Boot stage. Clip a few stalks, unroll the leaf sheath, and see whether or not there is a small, partially developed head encased in the sheath.

ITEM 6: STAGE OF MATURITY

CLASSIFYING HEADS IN "EARLY BOOT" AND "LATE BOOT" STAGES OF MATURITY

EARLY BOOT

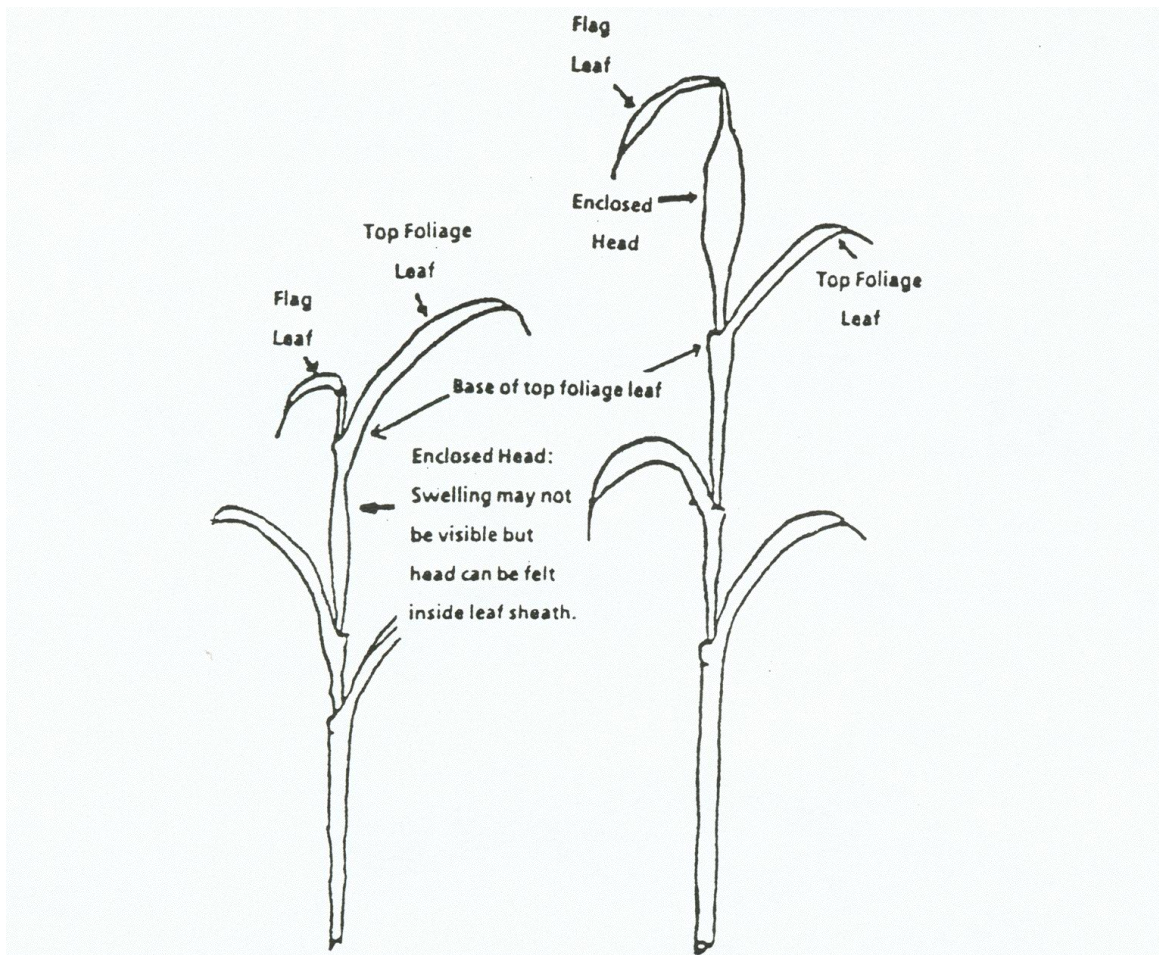

LATE BOOT

Maturity Code 3 - Late Boot or Flower (Heads Emerged), Includes Watery Kernels

The head has moved up the stem and swelling at the widest point has occurred above the base of the top foliage leaf. The sheath will be split, and the head will be partially or wholly emerged. The flower stage occurs soon after the head emerges, and small blooms or flowers begin to open at the middle of the head and blooming progresses towards each end of the head.

For our purpose, consider the unit to be in the late boot or flower stage from the time swelling at the widest point can be seen or felt above the base of the top foliage leaf until the head emerges and the watery clear liquid in the kernel has begun to turn milky.

Maturity Code 4 - Milk

Kernels formed in heads. Kernels of grain are soft, moist, and milky. When the grain is squeezed, a milky liquid can be observed. The plant is still generally green. One or two of the lower leaves may be dead, but the blades of the three upper leaves and the head are green. Signs of ripening (yellow spots or strips) are visible only on the edges or tips of the leaves.

Maturity Code 5 - Soft Dough

The grains can be crushed between the finger and thumbnail; the contents of most of the GRAINS are SOFT and can be kneaded LIKE DOUGH with ONLY A FEW GRAINS PER HEAD containing any milky liquid. The plant has changed to a golden tint (except in the purple-strawed varieties which are a pinkish purple color); the stalk is smooth and shiny, tough, and pliable. Only the upper-most leaves are swollen and green, the lower leaves being shrunken and brownish.

Maturity Code 6 - Hard Dough

The grains readily part from the head and are likely to shake out of the glumes. The grain is firm and though it may be dented by pressure of the thumbnail, it is not easily crushed. The characteristic color has become distinct. The yellow grains are paler, the red grains somewhat darker and flinty or mealy in character. The leaves are dry and shrunken. Wheat in this category may be swathed in some areas.

Maturity Code 7 - Ripe

Straw is full and brittle at this stage; the GRAIN is HARD and BREAKS IN FRAGMENTS when crushed. Harvest may be expected at this time.

Maturity Code 8 - Blank

This maturity code is used for fields with blank areas where the sample falls. There will be no plants in the sample unit.

Count of Stalks and Heads within Count Areas

Purpose: Prior to the final pre-harvest visit, the number of stalks and/or heads in the "count area" along with the heads clipped from "clip area A or B" are used to establish GROSS YIELD. Clip area sample heads provide a measure of grains per head and weight per head. Count area heads clipped during the final pre-harvest visit and shipped to the National Lab provide actual threshed grain weight per head adjusted to standard moisture obtained at time of lab threshing.

Counts of stalks, emerged heads and heads in late boot are to be recorded for individual rows (1, 2 and 3) for each unit. Where there are **no drill rows**, report the total number of stalks or heads in the unit in the Row 3 column, leaving Row 1 and Row 2 columns blank. Note on the form that there are no drill rows. Counts of detached heads are recorded for each unit (rather than by rows) in Item 9b, Row 2.

Important: Take care not to trample the wheat in the sample rows inside or near the sample units. Stalks and heads in the unit must be handled carefully to avoid affecting counts on future visits.

If wheat plants are growing in the middles between drill rows, the count of stalks for these plants is to be included with the count of stalks for the associated drill row. The row space or "middle" associated with the first row will always be in the direction of the second row and the "middle" associated with the second row will be the space between the second and third rows. The middle associated with the third row will be the space between rows three and four. The "middle" will include the stalks in the row it is associated with, but will extend only up to but not include the stalks in the next row.

The first item counts made in the units will vary between samples and between months depending on the stage of maturity. Boxed instructions in Item 6 define the first item to be counted in making the within unit counts. Starting with the item indicated by the instructions, counts will be made for all remaining items in order, except for detached heads (Item 9b), for which counts are made only on the final pre-harvest visit to the field. Use your hand counter.

Counting Stalks (or Stems) of Young Wheat

COUNTS WITHIN UNITS	UNIT 1			UNIT 2		
	Row 1	Row 2	Row 3	Row 1	Row 2	Row 3
7. Number of stalks (stems) in row	311	312	313	314	315	316

Important: Make counts in the Unit Count Area. Counts for Item 7 will be made only when the Unit 1 (or Unit 2 when Unit 1 is blank) maturity code is 1 or 2.

Item 7 is to be the count of all wheat stalks alive, damaged, or dead which emerge from the ground within the sample count unit. (The words stalk and stem can be used interchangeably in Item 7). Each wheat plant will generally have several stalks converging at the ground level like the ribs on an umbrella. For the very young plants, count only stalks that have at least ONE leaf off the main stalk. One leaf off the main stalk is defined as the presence of a foliage leaf, however small, together with a leaf associated with the growing tip of the stalk. See illustrations of Item 7 “Counting Stalks (or Stems) of Young Wheat”.

Care must be taken in making these stalk counts to ensure the necessary degree of accuracy, especially with young wheat. Generally, this will require getting down on your hands and knees, looking at the stalks at close range and separating them one by one with the point of a pencil while counting. For the purpose of this survey, do not count the small single leafed stems or stalks that do not have foliage leaves, and which are barely visible above the ground. By the first visit, most fields are expected to have some stalks with foliage leaves.

Counting Stalks (or Stems) of Young Wheat

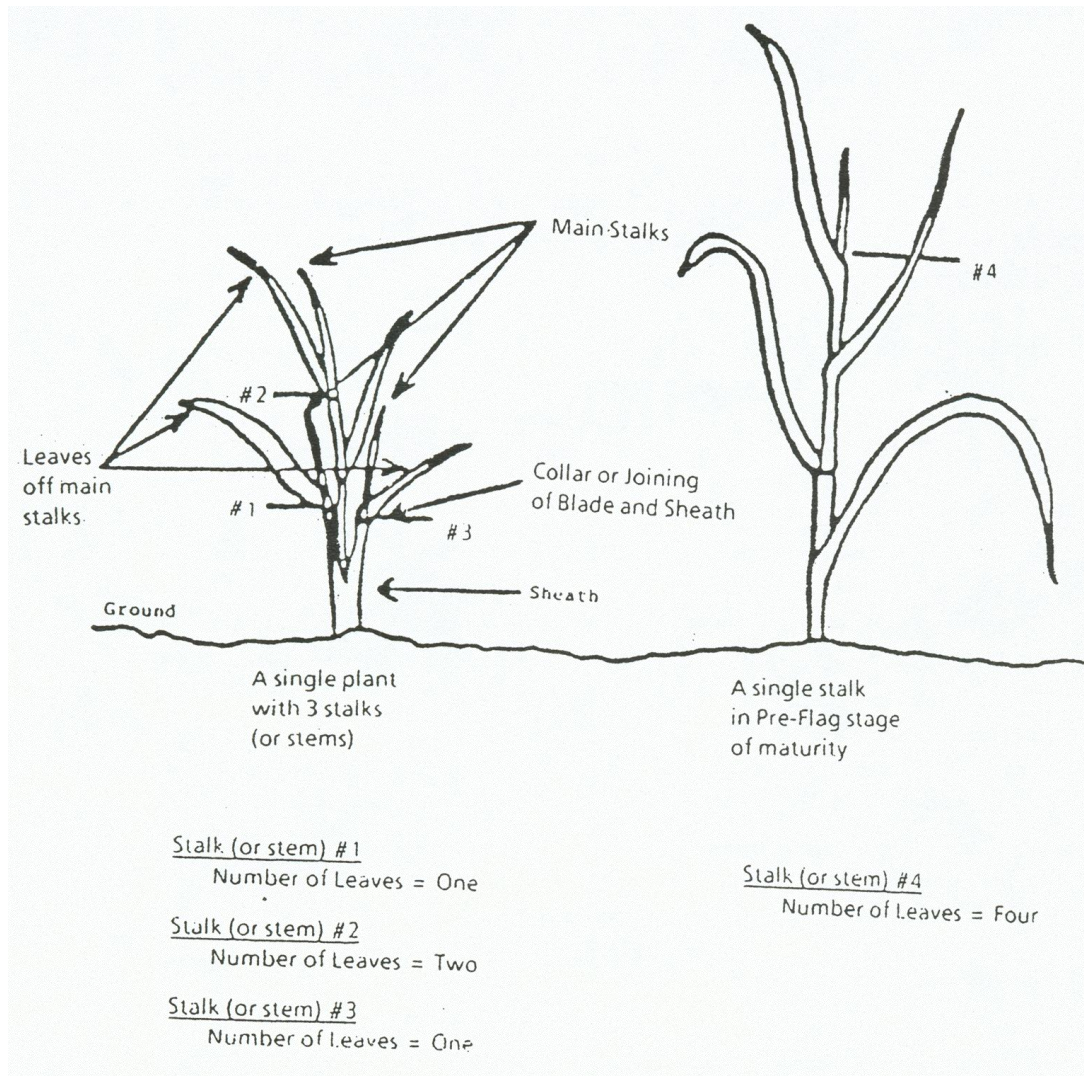

All stems or stalks within the unit are to be counted as wheat unless they can be identified as being grass or grain other than wheat. Stalks or stems identified as not being wheat are not to be included in the counts. Do not remove any stalks or stems from the sample unit (grass, grain, weeds, etc.) as this affects the environment of the remaining plants.

8. Number of heads in LATE BOOT	351	352	353	354	355	356
---------------------------------------	-----	-----	-----	-----	-----	-----

Important: Counts will begin with Item 8 when the Unit 1 (or Unit 2 when Unit 1 is blank) maturity code is 3 through 7.

The presence of a head in "Late Boot" (maturity stage 3) is determined by observing swelling at the widest point on the stalk between the flag leaf and the base of the top foliage leaf. See previous illustrations of Item 6 "Stage of Maturity".

Do not include any heads of other small grains which may be growing in the unit. If the Unit 1 maturity code is 6 or 7, the "Heads in Late Boot" within the two count areas will also be clipped and sent to the National Lab in accordance with the instruction in Item 12. There should be very few if the maturity stage is 6 or 7.

9. a. Number of emerged heads on all stalks	331	332	333	334	335	336
---	-----	-----	-----	-----	-----	-----

These are counts of all emerged heads (regardless of condition) attached to stalks within the count area. A head is to be counted as an emerged head when spikelets are **seen** through the split in the sheath leaf or beyond. Do not count a head as emerged if the sheath is split but a spikelet is not visible or when a spikelet can only be seen through a transparent but unsplit leaf. Do not include late boot heads recorded in Item 8. Do not include any heads of other small grains which may be growing in the unit.

If the Unit 1 maturity code is 6 ("Hard Dough") or 7 ("Ripe"), the heads within the two count areas (Unit 1 and Unit 2) will be clipped and sent to the National Lab.

b. Number of detached heads in unit	341	344
---	-----	-------	-----

This item is to be completed only on the final pre- harvest visit when the heads are clipped from within the count areas. Search the ground within the count areas after the emerged heads and heads in boot have been clipped. Record the number of detached heads (regardless of condition) which lie within the count area. These heads will have dropped from the stalks before the final visit. Enter count of detached heads for each unit (all three rows and middles) under Row 2. Any heads found will be sent to the National Laboratory along with the clipped heads.

Clipping Instructions

Clipping is dependent upon the maturity code, not the number of visits to the sample. When a sample is visited and the maturity for Unit 1 is 3, 4 or 5, clippings in the specified clip area of both units are required.

10. If the **MATURITY CODE** Circled in item 6 for Unit One (or Unit Two when Unit One is blank) is:
- Code 1 or 2: SKIP items 11 and 12. Enter enumerator and supervisor numbers and sign name.
 - Code 3, 4 or 5: Go to Item 11.
 - Code 6 or 7: Go to Item 12.
 - Code 8 (Both Units): Record dashes for appropriate items plus note on Form B and kit envelope that both units are in blank area. Enter enumerator and supervisor numbers, and sign name.

Maturity codes determine the sequence of questions after Item 10. Follow the Item 10 instructions carefully.

Note that the Unit 1 maturity code determines the action to follow. Always refer to the Unit 1 maturity code circled in Item 6 on the front of the Form B.

Maturity Codes 1 and 2 indicate immature wheat and Items 11 and 12 are skipped. No laboratory samples are required. Enter enumerator and supervisor numbers, check the form, and sign your name.

Maturity Code 3, 4 or 5 calls for completion of Item 11 using the specified row within the clip area of each unit. Maturity Code 6 or 7 indicates skipping Item 11 and completing Item 12 within the count area of both units. Maturity Code 8 indicates no plants in the unit count area. When both units are in blank areas, record dashes for Items 7, 8 and 9 and make a note on Form B and the kit envelope. Enter enumerator and supervisor number and sign name.

A diagram of a unit and clipping order is on the back of Form B.

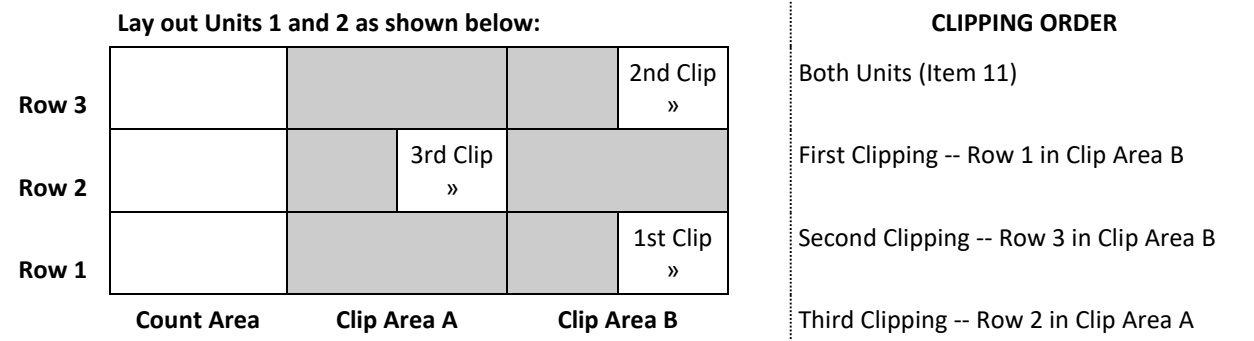

Clipping Immature Samples

Always be sure that clipping is done in the proper row and area by reviewing the diagram each month. The clip area and row numbers are specified on the Form B. Clip the area marked "1st Clip" when Item 10(b) maturity code requirements have been met the first time. On subsequent visits when maturity codes indicate clippings, clip the area marked "2nd Clip" or "3rd Clip" depending on the number of clippings this will be. Record the number of clippings on the kit envelope plus match the clipping diagram (Form B) to the unit to see what clippings have been done. Continue clipping on each visit until the Unit 1 maturity code is 6 or 7, then follow Item 10 (c).

All wheat stalks (regardless of condition) will be clipped from one-half of the specified row in the clip area of each unit. If the first half of the designated clip row is blank, no clippings will be sent in. Note on the Form B explaining the designated clip row is blank.

When no distinguishable row is present in the clip area, divide the clip area into 3 equal parts or thirds (7.2 inches or .6 feet) with the steel tape, and mark with blue florist stakes. Attach flagging ribbon between stakes (dotted lines). Each third will represent one row plus its associated middle.

Complete Item 11, 1-4 as shown on the back of Form B and explained below.

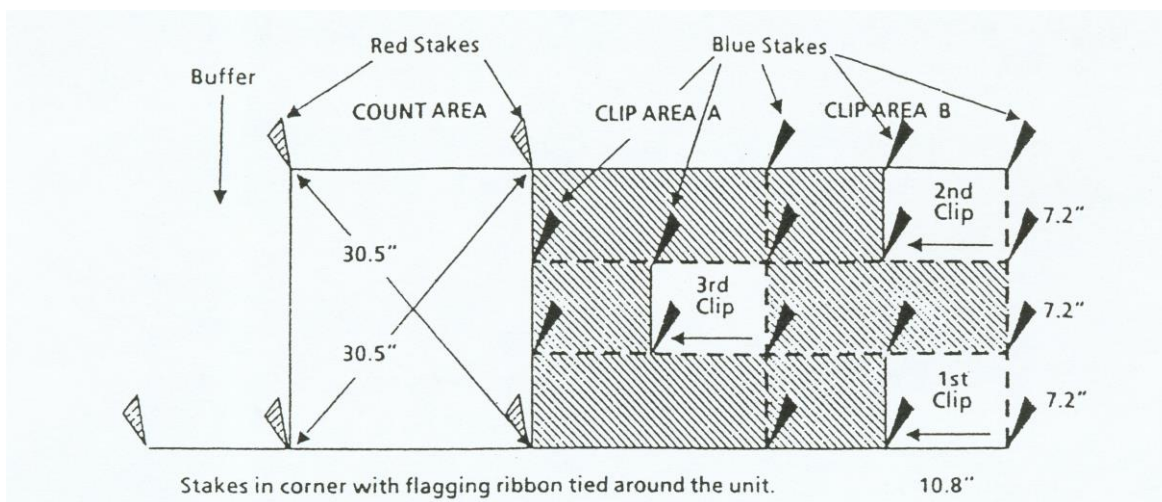

Step 1: Mark half-way point in specified row in clip area.

Using a florist stake, mark the midpoint of the specified row. Half-way on the 21.6 inch wheat frame is 10.8 inches.

Step 2: Mow (cut stalks within 2 inches of base) all wheat stalks (regardless of condition) in specified row until 5 Emerged Heads (if that many) are obtained or until one-half the row is completely mowed. Begin mowing at the end of the row farthest from the count area and mow in the direction of the count area. Examine each stalk for an emerged head as it is mowed; if present, clip the stalk 1/2 inch below the head. The purpose of the 1/2" clip is to standardize the weight of stems. Without this standard, longer stems would

mean higher wheat yields and shorter stems, lower wheat yields. Place the 5 (or fewer) emerged heads in the small bag. Record the count on the National (yellow) ID tag. Also when mowing, clip and count any heads in late boot and place in the medium size bag. Clip at the base of the top foliage leaf. Never go past the florist stake at the half-way point. In a thin wheat stand, it is possible to mow and not find 5 emerged heads.

Step 3: Mow the remaining stalks up to the half-way mark. Examine each stalk for emerged or late boot heads. Clip the stalks of emerged heads 1/2 inch below the head. Clip the late boot heads at the base of the top foliage leaf. Place the remaining emerged heads in the large bag and the late boot heads in the medium size bag.

Bagging Instructions

To help prevent broken heads in shipment:

- Limit heads per bag to only half volume
- Limit samples shipped per Tyvek envelope to one and follow these instructions:

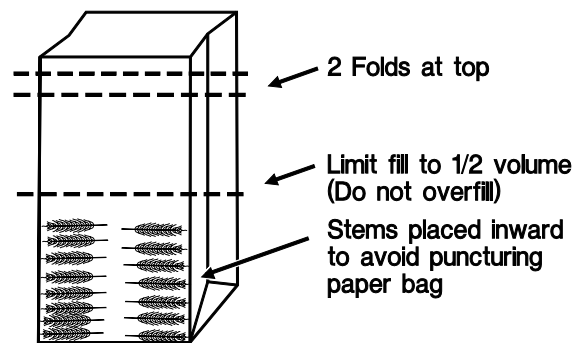

Step 4: Record the count of the remaining emerged heads and all the late boot heads on the National Lab ID Tag. After completing observations for Unit 2, check over all items on the Form B to make certain you have completed each step. Repeat Steps 1-4 for Unit 2 using same bags as used in Unit 1.

** Prepare one ID tag. Label all bags with sample number. Seal and place small and medium bag in the large bag. Verify National yellow ID tag and attach to outside of large bag with a rubber band.

** If Unit 2 Maturity Code is 2, skip Items 11 & 12, discard Unit 1 clippings and DO NOT send any clippings to the Lab. Be sure and enter enumerator and supervisor numbers and sign name.

Check () after placing large bag in a Tyvek envelope that has a shipping label addressed to the NATIONAL LAB. Skip Item 12, enter enumerator and supervisor numbers and sign name. Ship these samples at the end of each day, if not sooner.

Clipping Area ID Tags

WHEAT SAMPLE I.D. TAG CLIPPING AREA			
STATE	WA		
POID	830081350		
SAMPLE NO.	65		
FORM B DATE	5-01		
TYPE of WHEAT:	W.W. <input type="checkbox"/>		
ENUMERATOR	WYE KNOT		
		Unit 1	Unit 2
Maturity Stage	Code	3	3
Late Boot Heads	No.	17	18
First Five (or less) Emerged Heads	No.	5	5
Remaining Emerged Heads	No.	10	10
Total - All Heads	No.	32	33
SHIP SAMPLE TO NATIONAL OPERATIONS DIVISION LAB			

NOTE: It is very important that the date on the ID Tag is the same as the date on the Form B. The dates must be the same to allow for computer matching between the Form B data and the National Lab data.

Use the "yellow" ID tag to identify the sample of preharvest heads clipped from the clipping area when the Unit 1 maturity is 3, 4 or 5.

One tag will be used for each sample. **All** lines of the upper identification section must be completed.

Separate columns for Unit 1 and Unit 2 are provided in which to record maturity codes and counts. Maturity codes for each unit must agree with codes circled in Item 6 on the front of Form B.

NOTE: The importance of annotating the maturity code on the crop ID tag really needs to be emphasized. It is an incredibly easy thing for enumerators to do, but when they leave it off it slows down lab

check-in and creates many back-and-forth emails between the RFO and lab.

Record, for each unit, the actual number of emerged heads mowed for the first five (or fewer) emerged heads, and the number of remaining emerged heads clipped from the specified row.

For each unit, add and record the total number of all heads mowed, clipped and placed in the large bags. Include the first five (or fewer) heads mowed. Verify that the Tyvek envelope containing the sample has a shipping label properly addressed to the National Laboratory.

Harvesting Mature Samples

If, during the regular survey period, the Unit 1 maturity stage is "hard dough" or "ripe" (Code 6 or 7), all heads (regardless of condition) inside both count areas are to be clipped and all detached heads (regardless of condition) on the ground in the count area are to be gleaned regardless of when farmer will harvest. Final preharvest visits made between survey periods should not be made more than three days ahead of farmer harvest.

Heads in "Late Boot", emerged heads, and detached heads will be clipped and counted separately. All heads in each count area will be clipped and placed in a large bag, one bag for each unit. Follow Steps 1 through 4 below for each unit.

Step 1: Clip and Count all Heads in Late Boot in Row 1 - Record in Item 8. Clip at the base of the top foliage leaf.

Step 2: Clip and Count all Emerged Heads in Row 1 - Record in Item 9a and place emerged heads in the same bag with late boot heads. Clip stalk 1/2 inch below head before placing in bag.

Important: Remember to record the Step 1 count before going on to Step 2 and mixing the emerged and late boot heads.

Clipping and Mowing

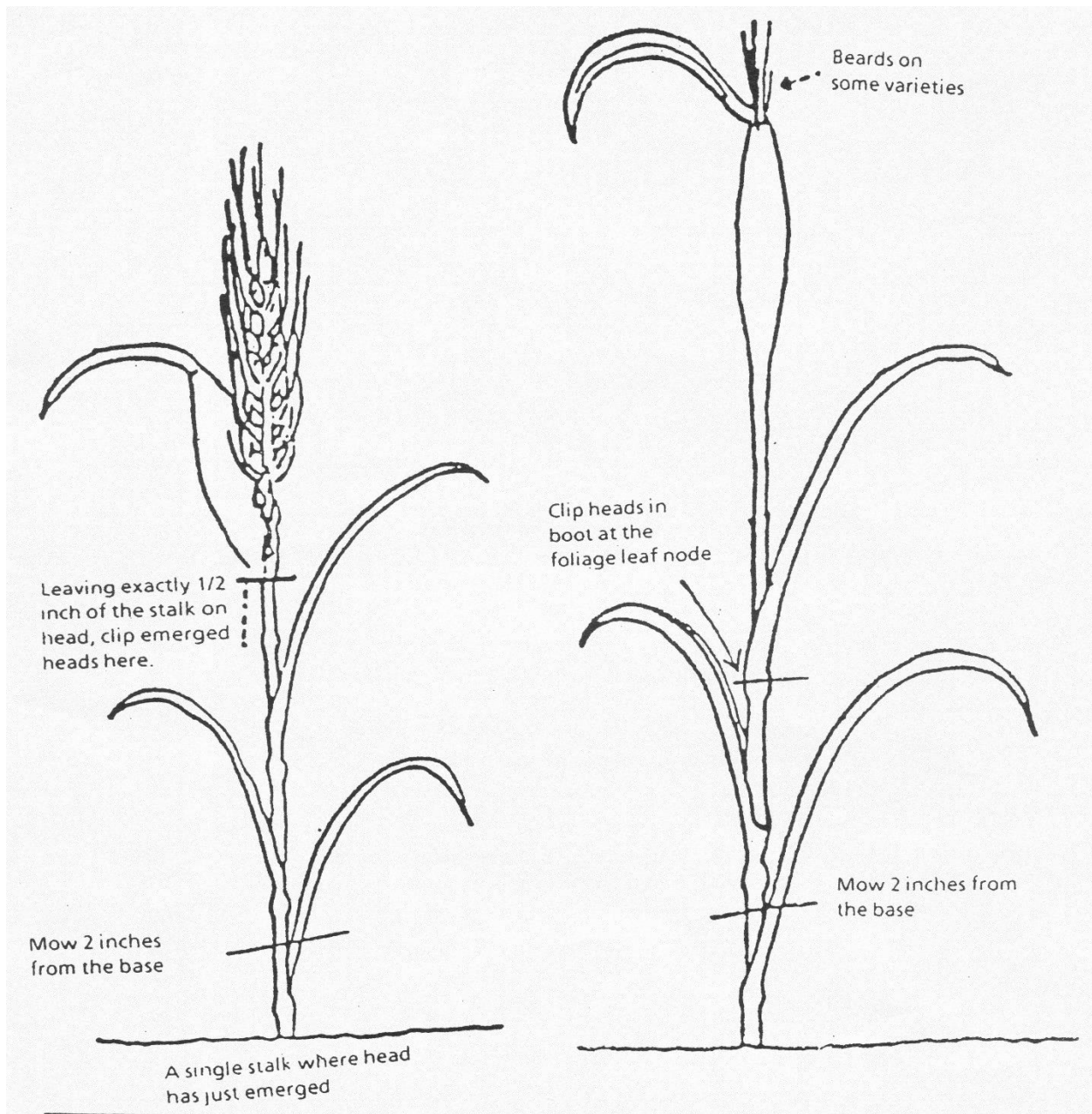

Bagging Instructions

To help prevent broken heads in shipment:

- Limit heads per bag to only half volume
- Limit samples shipped per Tyvek envelope to one and follow these instructions:

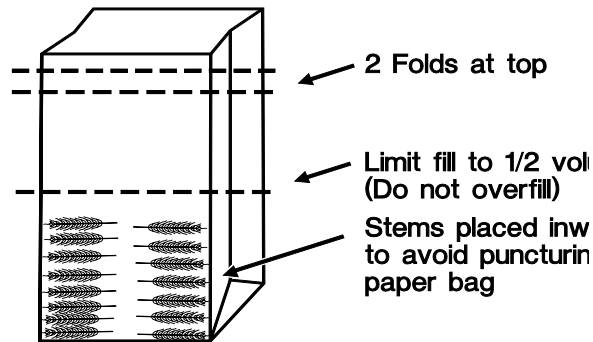

Step 3 Repeat Steps 1 and 2 for ROW 2 and ROW 3. Record counts. Care must be taken to record counts for the proper unit and row in Items 8 and 9a. For broadcast units, record all counts in Row 3. Take care to make accurate counts.

Step 4: Pick up and count all detached heads on the ground in the unit and record in Item 9b. Place them in a large bag with the clipped heads.

Search within the count areas for any detached heads on the ground. Also pick up any loose kernels laying on the ground in the count area.

Step 5: Record heads clipped in Items 8 and 9a of the Form B onto pink ID tags, one for each unit. Add a note to the ID tag if one unit is missing or there are no heads to clip. If it is necessary to use two shipping bags for one sample, write "1 of 2" and "2 of 2" on the bags and tie the two bags securely together. Attach one ID tag to each large bag. Check () after placing the bags in a Tyvek envelope that has a shipping label addressed to the NATIONAL LABORATORY.

Enter enumerator and supervisor numbers and sign name.

After completing observations for Unit 2, check over all items on the Form B to make certain you have completed each step.

Final Preharvest or Postharvest ID Tags

WHEAT SAMPLE I.D. TAG COUNT AREA AND GLEANINGS			
STATE	WA		
POID	830081350		
SAMPLE NO.	65		
Form B Date	7-01		
Form E Date			
TYPE of WHEAT:	W.W. <input type="checkbox"/>		
Enumerator	WYE KNOT		
UNIT (Circle)	1	2	
MATURITY CODE of UNIT (Circle)	6	7	Other
HEAD COUNTS: Copy from Form B into block below			
Item	Row 1	Row 2	Row 3
8			
9(a)	56	56	53
9(b)			
IF POST-HARVEST GLEANINGS: CHECK <input type="checkbox"/>			
SHIP SAMPLE TO NATIONAL OPERATIONS DIVISION LAB			

Use the "Pink" ID tag to identify the sample of final preharvest heads harvested from the count area when the Unit 1 maturity code is 6 or 7. Also use this tag for postharvest samples (Form E.).

All lines of the upper section must be completed for proper identification of samples.

NOTE: It is very important that the date on the ID Tag is the same as the date on the Form B. The dates must be the same to allow for computer matching between the Form B data and the National Lab data.

Two tags of this type will be used for each sample, one for each unit. Identify each by circling the appropriate unit number.

NOTE: The importance of annotating the maturity code on the crop ID tag really needs to be emphasized. It is an incredibly easy thing for enumerators to do, but when they leave it off it slows down lab check-in and creates many back-and-forth emails between the RFO and lab.

Designate the maturity code of the unit which was circled in Item 6 of Form B. Most units will have a 6 or 7 code. Use the "other" category for 1) maturity code 5, and the farmer will immediately harvest anyway, 2) maturity code 8 to show the unit is in a blank area. When both units fall in blank areas (two code 8's), ship two ID tags together to the National Lab in a separate envelope with other National Lab samples. Note on the ID tag sufficient explanations for any of these situations.

Copy the number of heads counted and recorded on Form B for the unit circled. Make sure the number of heads clipped for each row and detached heads picked up in the unit and shipped to the National Lab are in agreement with the counts entered.

Verify that the Tyvek envelope is properly addressed to the National Laboratory and the sack contains the lab samples from both units and the Form E questionnaire if this is a gleaning sample.

Harvesting for Swathed Wheat Fields

During Survey Period

If the maturity stage of Unit 1 (or Unit 2 when Unit 1 is blank) is Code 6 or 7 on this visit, the heads in the count areas will be clipped and sent to the National Laboratory.

If the maturity stage of Unit 1 has not reached Code 6 and the farmer will swath within 3 days, you will need to complete two B forms.

The first B form will follow normal procedures, counts will be made, and clipping will be done in the clip area as instructed on Form B. Be sure to send in the Form B and date (MMDD) this Form B using the date of the field work.

You will complete a second Form B and clip in the count area of each unit according to the following instructions:

- Step 1:** All stalks with a head attached in the count unit should be clipped at about the same height as the straw will be cut in the swathing operation. Extreme care must be taken so that heads and grain are not lost.
- Step 2:** The heads with straw attached from each unit should be tied together, placed in a Tyvek envelope (similar to those used for shipping), or large paper bags if Tyvek envelopes are not available, and identified by segment number, sample number, and unit number. Be sure to include all stalks with heads (both emerged and in the boot).
- Step 3:** These clippings should be taken from the field and stored in a place where they will not be destroyed by mice, birds or other animals. The period of storage shall not exceed one week.
- Step 4:** After the wheat has cured to the point where it would be if it were in the swath, the heads should be clipped from the straw and sent to the National Laboratory, following the regular clipping instructions. At this point you will re-evaluate the maturity of the sample. Update maturity codes on the Form B and the tags. If maturity code is not 6 or 7 after one week, call your Survey Statistician. Be sure to send in the Form B showing this as the final preharvest visit (maturity code 6 or 7) and date (MMDD) this Form B using the shipping date.
- Step 5:** Be sure each unit is properly identified from the time it is clipped until it is shipped to the laboratory.
- Step 6:** Whenever this procedure is used, write a note on the Form B identifying this as a "swathed" field.

Between Survey Periods

Enumerators will make this final pre-harvest visit to sample fields just prior to swathing by the farmer. Do not make this visit more than 3 days in advance of swathing.

If the maturity stage of Unit 1 (or Unit 2 when Unit 1 is blank) is code 6 or 7 on this visit, the heads in the count areas will be clipped and sent to the National Laboratory.

If the maturity stage has not reached code 6, follow steps 1 through 6 above. Clip from the count area only. Only one Form B is required.

Form

B

FORM B WINTER WHEAT YIELD COUNTS - 2024

OMB No.: 0535-0088
Approval Expires: 7/31/2026
Project Code: 101
Survey ID: 3098



United States
Department of
Agriculture



NATIONAL
AGRICULTURAL
STATISTICS
SERVICE

Date: _____

1. Has operator applied pesticides with organophosphorus content to the sample field?

Yes No

If YES, enter latest application date _____ and name of pesticide _____

UNIT LOCATION

2. Number of paces along edge of field.....

UNIT 1	UNIT 2

3. Number of paces into field.....

4. UNIT LOCATION CODE.....

1 First Sample Count
2 Unit relocated this month
3 Sample counted previously

Enter Code

UNIT 1	UNIT 2
305	307

When unit is Coded 3, go to item 6; otherwise go to item 5.

5. ROW SPACE MEASUREMENTS

a. Measure distance from stalks in Row 1 to stalks in Row 5.....

Feet & Tenths

UNIT 1	UNIT 2
301	303

6. STAGE OF MATURITY: (Circle one code for each unit)

MATURITY STAGE	PRE-FLAG	FLAG OR EARLY BOOT	LATE BOOT OR FLOWER	MILK	SOFT DOUGH	HARD DOUGH	RIPE	BLANK
UNIT 1 Count Area	300 1	300 2	300 3	300 4	300 5	300 6	300 7	300 8
UNIT 2 Count Area	302 1	302 2	302 3	302 4	302 5	302 6	302 7	302 8
If Unit One Maturity is	1 or 2, start counts with item 7		3, 4, or 5, start counts with item 8			6 or 7, start counts with item 8		8. Substitute Unit Two when both 8, Go to item 10

COUNTS WITHIN UNITS

7. Number of stalks (stems) in row.....

8. Number of heads in LATE BOOT.....

9. a. Number of emerged heads on all stalks

b. Number of detached heads in unit.....

UNIT 1			UNIT 2		
Row 1	Row 2	Row 3	Row 1	Row 2	Row 3
311	312	313	314	315	316
351	352	353	354	355	356
331	332	333	334	335	336
341			344		

(Complete 9b only on Final PRE-HARVEST VISIT)

Form – B: WHEAT

10. If the MATURITY CODE circled in item 6 for Unit One (or Unit Two when Unit One is blank) is:
- Code 1 or 2: SKIP items 11 and 12. Enter enumerator and supervisor numbers and sign name.
 - Code 3, 4, or 5: Go to item 11.
 - Code 6 or 7: Go to item 12.
 - Code 8 (Both Units): Record dashes for appropriate items plus note on Form B and kit envelope that both units are in blank area. Enter enumerator and supervisor numbers and sign name.

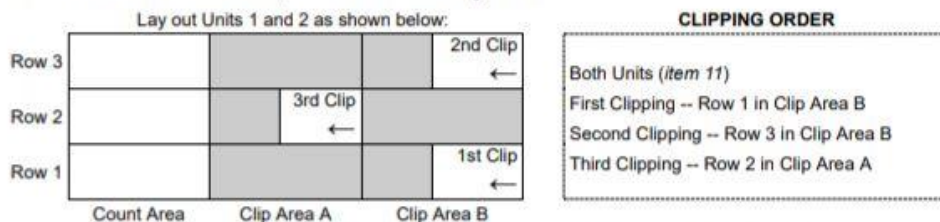

11. WITHIN CLIP AREA: Make clippings in the designated ROW within Clip Area OF EACH unit following steps below.

If Unit 2 Maturity Code is 2, enter enumerator and supervisor numbers below and sign name.
Discard Unit 1 clipping and DO NOT send any clippings to the lab.

Step 1 -- Mark half-way point in specified row in clip area.

Step 2 -- MOW (cut stalk within 2 inches of base) all wheat stalks in specified row until 5 Emerge Heads (if that many) are obtained OR until one-half the row is completely mowed. Begin mowing at the end of the row farthest from count area and mow in direction of count area. Examine each stalk for emerged head as it is mowed; if present, clip stalk 1/2 inch below the head. Place the 5 (or less) emerged heads in a small bag. Record count on YELLOW I.D. tag. Also, when mowing, clip and count any heads in late boot at base of top foliage leaf and place in a medium size bag

Step 3 -- MOW remaining stalks up to the half-way mark. Examine each stalk and determine which ones are emerged heads and late boot heads. CLIP the stalks 1/2 inch below the emerged head or at base of top foliage leaf for late boot heads. Place the remaining emerged heads in a large bag and the late boot heads in a medium bag.

Step 4 -- Record the count of the remaining emerged heads and the late boot heads on the YELLOW I.D. tag.

Repeat steps 1 through 4 for Unit 2 using same bags for emerged heads and late boot heads as used in Unit 1.
Prepare one I.D. tag. Label all bags with sample number. Seal and place the small and medium size bags in the large bag. Seal large bag. Verify and date YELLOW I.D. tag and attach to outside of large bag.

Check here after placing the large bag in a Tyvek envelope addressed to NATIONAL LABORATORY enter enumerator and supervisor numbers and sign name.

12. WITHIN COUNT AREAS -- Clip and Count all heads in count area of BOTH units following steps below.

Use a separate large bag for each unit.

Step 1 -- Clip all heads in Late Boot at base of top foliage leaf in Row 1 - Compare with item 8 count

Step 2 -- Clip all Emerged heads 1/2 inch below head in Row 1 - Compare with item 9a count and place emerged heads in same bag with late boot heads.

Step 3 -- Repeat steps 1 and 2 for **Rows 2 and 3.** -- Check counts.

Step 4 -- Pick up all **Detached Heads** on ground in unit counted in **item 9b.** Place in bag with clipped heads.

Copy recorded heads from items 8 and 9 of Form B onto PINK I.D. Tags. Date and attach one I.D. Tag to each large bag.

Check here after placing the large bag in a Tyvek envelope addressed to NATIONAL LABORATORY

13. Did a supervisor assist you in working this sample?

Yes No

ENUMERATOR: _____

UPS Tracking Number: _____

(For samples sent to National Laboratory)

Enumerator Number	390
Supervisor Number	391
Evaluation	393

STATUS CODE 380

Shipping to the Objective Yield National Lab

Good Shipping Procedures:

- Reduce transit time
- Reduce loss of samples whenever a shipping tag is damaged in transit
- Preserve sample quality
- All samples should (must) be sent the day of or the morning after they are collected up to the 1st of the month.
- All samples sent from the first of the month to the day prior to the preliminary summary should (must) be sent next day air.
- All samples collected from the preliminary summary to the next survey period (usually the 24 or 25) must be sent the day of or the morning after they are collected, using 2nd day air.

Shipping Samples in the Tyvek Envelopes:

- Include both units if available and if both will fit into one Tyvek envelope. Include an ID tag with each unit. If only one unit is being shipped, include a second loose ID tag for the missing unit showing the reason for its absence (lost to harvest, not planted, drowned out, blank area, etc.)
- Tyvek envelopes will be used for shipping Wheat Objective Yield Survey samples. Regional Field Offices will be using the **12"x 15.5"** or **18"x 23"** envelopes for the wheat samples. Enumerators can decide which size fits best for each sample/gleaning.
- FOs should place a shipping label on the Tyvek envelope and seal it for shipping to the NOD. The address should be:

LAB COORDINATOR
3145959611
USDA-NASS OY LAB
9700 PAGE AVENUE SUITE 400
SAINT LOUIS, MO 63132-1555

Shipping Options

There are two procedures for shipping samples to the National Lab. Field enumerators should utilize UPS shipping when available.

UPS 2nd Day Air or UPS Next Day Air Option



2nd Day Air

- The samples should be taken to a UPS drop off location or a UPS store. If approved, you may also request a pickup by UPS.
- UPS Representatives recommend placing a strip of tape over the seal as an extra precaution.
- **Lab samples should be shipped within 24 hours upon completion.**
- **UPS Next Day Air should be used for field work shipped the last two days of the survey period.**

USPS Option



- The samples should be taken to the front desk of a post office or sub-station that is still open, unless you have made previous arrangements with the post office where you drop the samples off. The post office may be apprehensive if they find the Tyvek envelope in an outside drop box without their prior knowledge.
- **Lab samples should be shipped within 24 hours upon completion no matter how it is shipped.**

Packaging and Shipping Wheat Samples Dos and Don'ts:

- Do:** Ship as soon as possible after clippings and/or gleanings have been taken.
Samples should be shipped within 24 hours from the time they were taken from the field.
- Do:** Clip the stalk of emerged heads ½" below head (wheat) before placing in bag. (Interviewer's Manual, page 515) This affects the weight of the heads in the lab.
- Do:** Make special notes such as "Unit 1 harvested by farmer before sample could be taken" are helpful.
- Do:** Use paper bags for wheat.
- Do:** Use paper bags for post-harvest gleanings and enclose with the Form E in the envelope. If the gleaned grain is very wet, you may need to use Tyvek envelopes instead of paper bags to eliminate the possible problem of paper bags bursting inside the envelope.
- Do:** Completely fill out the ID tag, making sure that the date and POID on the ID tag matches the date and POID on the Form B or Form E. The lab will use the date on the ID tags for the lab forms.
- Do:** Place ID tag on the outside of paper bag. Secure bag with rubber bands.
- Do:** Ship only one sample (2-units) per Tyvek envelope. When paper bags are broken during shipping, there are enough problems to contend with when only one sample is involved in the envelope.
- Do:** Ship Form B's to the office in a separate envelope. Mail forms for refusals or "no gleanings" to the Regional Field office, not to the lab.
- Do:** Secure the Tyvek envelope with extra tape.
- Do:** **Record the UPS tracking shipping number for the Form B and Form E samples sent to the NOD Lab.**

- Don't:** Use red pencil or pen on ID tags.
- Don't:** Staple ID tags to paper or plastic bags (corn).
- Don't:** Secure the Tyvek envelopes with cord, rubber bands, wire, etc.
- Don't:** Use poly bags for post-harvest gleanings unless sample is too wet.

– NOTES –

Chapter 6 – Form E

General

The purpose of the Postharvest gleanings (Form E) is to provide the harvest loss used in adjusting the gross yield (calculated from Form B) to a net yield.

Form E is completed for every fourth sample (samples with numbers evenly divisible by 4). Do the gleanings only after the sample field has been harvested, preferably the same day, but it must be done within 3 days of harvest. Additional gleanings samples may be selected after the start of the survey. You will be notified of any changes/additions.

If the sample field has been disked, plowed, grazed, straw picked up after harvest or not harvested for grain, a recently combined alternate field will be gleaned. The alternate field will be one in the same operation. If a recently combined field is available, mark the Form E "Alternate Field" in the field notes.

If you are unable to make a postharvest gleanings count, report the reason in the field notes space. You should complete a Form E for the sample field even if you were unable to collect a post-harvest gleanings sample.

Location, Layout and Markings

The Form E units are located using the same number of paces as used for Form B units, plus five. These paces are recorded on the Form E. To locate, lay out and mark the gleaning units, follow the steps outlined below and the illustration in this section.

Step 1: The postharvest unit paces to use are indicated on Form E. Walk the number of paces along the edge of the field and into the field. Do not mark them permanently as you will not return to these units.

Step 2: After you have taken the last of the required paces, place a yardstick so that it touches the toe of your shoe and crosses four rows of stubble immediately in front of your toe or to the left of your toe, depending on the direction of the rows at that point.

If no drill rows can be distinguished, see the broadcast procedures given in Chapter 5 and illustrations to lay out the gleanings unit.

Step 3: Lay out the 5-foot buffer zone. Anchor the zero end of the 50 ft. steel tape just beyond the yardstick and directly alongside the plant stubble in Row 1. The zero end of the tape must be anchored firmly and close to the ground so it will not move when the measurement is being made. Insert a red florist stake (anchor stake) at this anchor point.

- Step 4:** In Row 1, place a red starting florist stake exactly 5 feet from the anchor point. The florist stake should be placed in the row of stubble. This marks the buffer zone.
- Step 5:** Reposition the yardstick within the 5-foot buffer so that it touches the starting florist stake and crosses four drill rows. Be careful to position the yardstick in a straight line from the starting florist stake across the 4 rows of stubble. The end of the yardstick closest to the starting florist stake is always the lower left-hand corner of the gleaning unit.
- Step 6:** The wheat frame identifies the length of row included in the gleaning unit. Always place the frame to the right of the yardstick. Working from outside the unit carefully slip the frame into Row 1 through the base of the stubble with the inside corner of the left tine touching the florist stake just placed in Row 1. The tine(s) of the frame may divide a plant that has many stalks like ribs of an umbrella. You are to slip the frame through the base of the stubble immediately to the right of the yardstick with the starting stake touching the inside corner of the left tine; thereby, allowing the tine to determine which stalks and stubble are included or excluded for the unit. Do not move stubble in or out of the frame. The 2 tines should extend through the stubble with the back of the frame parallel to the row. Insert the ending red florist stake in the row at the point where the inside corner of the frame tine crosses the row of stubble.

Important: Be sure that the inside corner of the tines are touching the florist stakes. This marks Unit 1, Row 1 of the gleaning area.

- Step 7:** In Row 4, place a red florist stake exactly at the outside edge of the 5-foot buffer so that it touches the yardstick. This time the florist stake should be placed on the inside of Row 4 but away from the base of the plant stubble to exclude Row 4.
- Step 8:** Next slip the wheat frame into Row 4 through the base of the stubble with the inside edge of the left tine touching the florist stake just placed on the inside of Row 4. The frame will be inserted to exclude the stubble in Row 4 so that when the four stakes are connected with flagging ribbon, three drill rows and three middles will be included. Row 4 stubble should be excluded. This will mark exactly the area to be gleaned and will eliminate accidental shifting of the boundaries while gleaning is in progress. The 2 tines should extend through the stubble (from the inside of the unit) with the back of the frame parallel to the row.

Important: Be sure that the inside corners of the tines are touching the florist stakes.

The following illustration must be strictly followed to assure accurate harvest loss indications. To glean outside these boundaries will erroneously expand harvest loss and to glean less than all the wheat inside the boundaries will erroneously reduce the harvest loss indication.

<u>Position</u>	<u>Procedure</u>
1 Head	Include
2 Attached Stalk	Include
3 Loose Grain	Include
4 Detached Stalk	Exclude
5 Head	Exclude
6 Attached Stalk	Exclude
7 Head	Exclude
8 Head	Include
9 Detached Stalk	Include

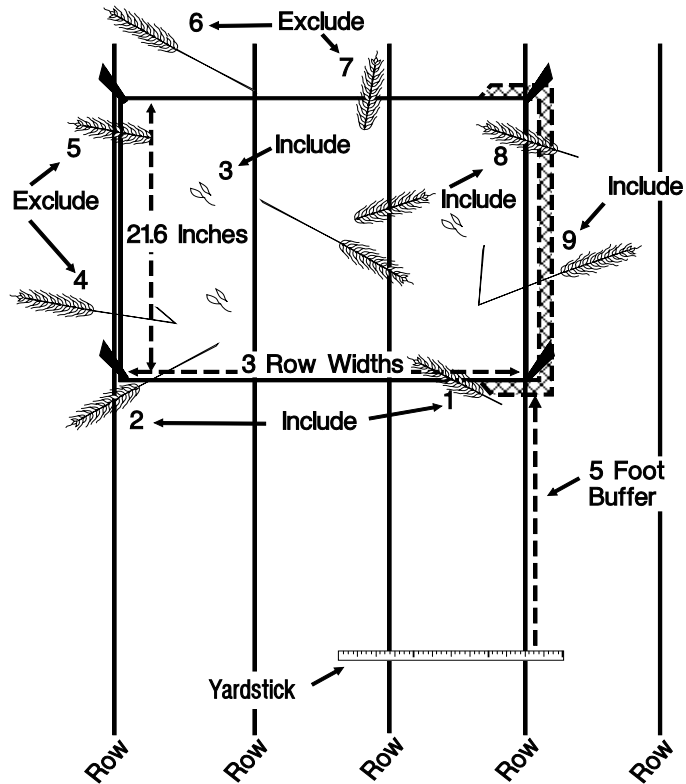

Rules:

Rule 1: Include detached stalks with heads and loose grains that are on the two starting corner boundaries (up border and right border). The starting corner is the florist stake marking the 5 foot buffer (positioned at the lower left corner of the unit).

Rule 2: Exclude detached stalks with heads and loose grains that are on the two remaining boundaries.

Rule 3: Attached stalks within the boundaries are included.

Rule 4: Attached stalks outside the boundaries are excluded.

Laying Out the Gleaning Unit

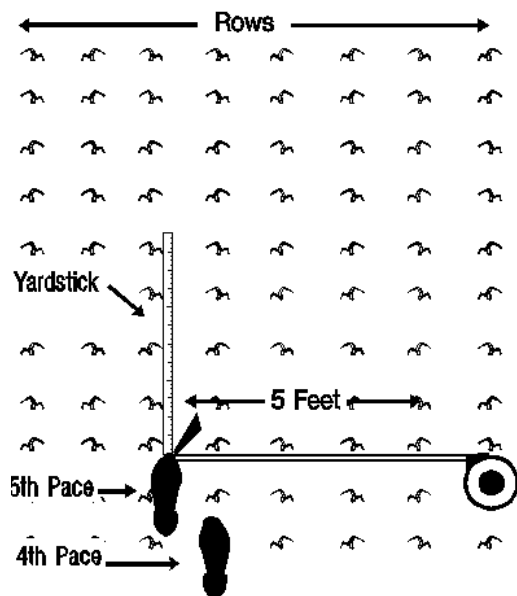

Steps 2, 3: On last pace lay yardstick down at toe, anchor 50-ft tape, insert florist stake at anchor.

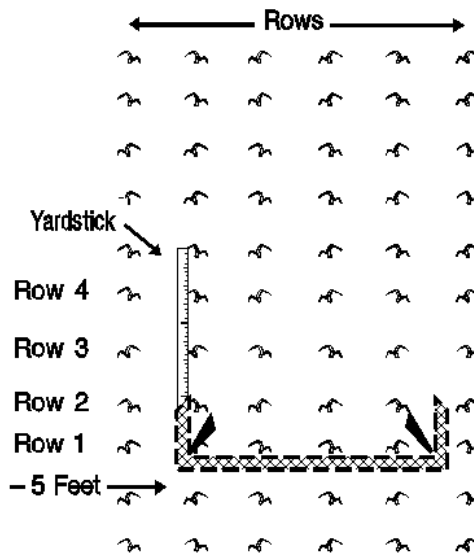

Steps 4, 5, 6: Mark Row 1 exactly 5-ft. from anchor point, reposition yardstick, slip frame with left line touching starting florist stake, then insert ending florist stake.

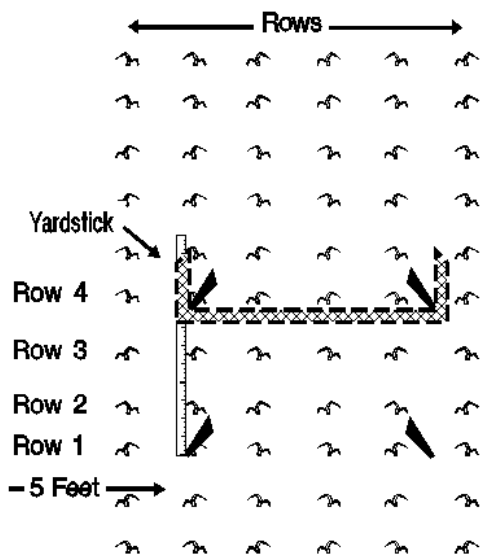

Steps 7, 8: Mark Row 4 at 5-ft. buffer (touching yardstick and inside Row 4), slip frame with left line touching florist stake, move florist stake up to but excluding Row 4 stubble, then insert ending florist stake.

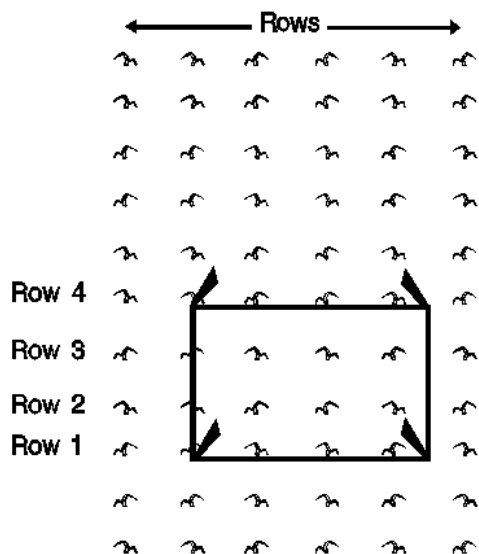

Connect 4 florist stakes with flagging ribbon.

Form E Completion

Be sure the identification (usually a label) is in the space provided at the top of each Form E. If not, you must record the identification from the sample field kit envelope.

Record the date in the space provided at the top of the form.

UNIT LOCATION (Diagram on reverse side)	UNIT 1	UNIT 2
1) Number of paces along edge of field.....	+ 5	+ 5
2) Number of paces into field.....	+ 5	+ 5

Unit location paces are recorded. You are to add 5 paces (preprinted) to the recorded number to locate the units.

	UNIT 1	UNIT 2
3) Measure distance from stalks in Row 1 to stalks in Row 5.....Feet & Tenths	704 .____	705 .____

Measure the distance (in feet and tenths) across four drill row spaces at the beginning of the buffer zone with the steel tape. Start at the center of the stalks in Row 1 and measure across four spaces or middles, to the center of the stalks in Row 4 (see the Measuring Distance Across Row Spaces illustration in Chapter 6).

Attention: Make a note of unusual row spacing because of double rows, skips, lapping by drill, etc. If a unit falls in an area where no drill rows can be distinguished, you will not complete this item.

Item 4a: All Unthreshed Whole Heads

Item 4a requires that you pick up whole heads which lie within the unit. If there are any headed stalks which have not been severed from the ground (for example, lodged stalks or short stalks missed by the combine), these heads should be gleaned only if the stalks emerged from the ground **inside** the unit. Place these whole heads in a paper bag.

Item 4b: All Partly Threshed Heads

If any partly threshed heads or loose grains are found, place them in the same bag with the whole heads. This requires that you go over the ground carefully, inch by inch. You must pick up every grain within the unit.

Item 4c: All Loose Wheat Grains

Every grain in the unit is important. On the average, each 80 grains picked up within a unit is equal to one bushel of harvest loss per acre.

Some enumerators have found that under dry conditions a dustpan and a small whisk broom are helpful in the gleaning operation. The loose grain and partly threshed heads on the ground can be swept up, dumped on a screen for cleaning out the dirt and then bagged.

Check () for each unit to show the heads and loose grains were picked up and placed in bags.

All gleanings for each unit should be put into the sample bag. Complete the sample identification section of the ID tag. Check () on the pink identification tag for the Postharvest Gleanings and attach it, facing out, to the paper bag. Place the bag in a Tyvek envelope addressed to the National Laboratory.

Enter enumerator and supervisor number and sign name.

Put the completed Form E in the Tyvek envelope with the corresponding sample. Ship the Tyvek envelope with the Form E and gleanings sample to the National Laboratory.

Project Code 101

OMB No. 0535-0088: Approval Expires 3/31/2023



**FORM E WINTER WHEAT YIELD SURVEY
POST-HARVEST GLEANINGS**



**NATIONAL
AGRICULTURAL
STATISTICS
SERVICE**

Date: _____

NOTE: The post-harvest field gleanings should be completed as soon after harvest as possible, and must be done within 3 days after harvest. If the sample field has been plowed, disked, or pastured since harvest, select an alternate field for gleaning if one is available in the tract or nearby field(in the sample operation) for list frame sample(s).

UNIT LOCATION (Diagram on reverse side)

1. Number of paces along edge of field.....

UNIT 1	UNIT 2
+ 5	+ 5
+ 5	+ 5

2. Number of paces into field.....

3. Measure distance from stalks in Row 1 to stalks in Row 5.....

Feet and Tenths

704 _____	705 _____
--------------	--------------

GLEANINGS (Place all gleanings from both units in one paper bag)

4. PICK UP IN BOTH UNITS --
- a. All unthreshed whole heads.....
 - b. All partly threshed heads.....
 - c. All loose wheat grains.....

CHECK EACH BOX AS
COMPLETED

<input type="checkbox"/>	<input type="checkbox"/>
--------------------------	--------------------------

5. Was an alternate field used for making post-harvest observations?

Yes - (Indicate in Field Notes) No

FIELD NOTES: If post-harvest observations cannot be made, give reasons here.

6. Did a supervisor assist you in working this sample? Yes No

Shipping Instructions:

- a. Ship this Form E to the National Lab in the same Tyvek envelope as the gleanings.
- b. Attach completed ID tag to the paper bag(s) containing gleanings, and place bag(s) and this Form E in a Tyvek envelope.
- c. Do not place Form E inside paper bag.

Enumerator Number	790
Supervisor Number	791
STATUS CODE	780

ENUMERATOR: _____

– NOTES –

Chapter 7 – CAPI Data Entry

General

CAPI will be used for data entry for Form A-1 and B records. All data will be recorded on the paper forms. After the data collection is complete each day, the enumerator will access their assignment listing on the iPad and enter the data for their samples into the CAPI exactly as it was recorded on the paper. Submit the record after data entry has been completed.

***** IMPORTANT: NEVER take the iPad into a field under any circumstance. *****

Enumerators may decide to enter the data immediately after they have completed data collection or at the end of the day after all their day's work has been completed. To take full advantage of the mobile data collection technology developed for this survey it is highly recommended for all data to be entered and submitted by the end of the day it was collected. RFO survey coordinators will provide specific instructions on how they wish to handle the completed paper Forms for samples entered and submitted via CAPI. Also enter any comments you have into CAPI along with your data.

Survey Designer CAPI Editing System

CAPI Form B instruments are designed in a system called Survey Designer. In this system, the programmer can develop certain "edits". An edit will assist the enumerator in making sure certain required cells are complete before final submission of the form through CAPI. These edits are a system of background checks within the Form B CAPI instrument which will notify users of specific corrective actions that must be taken before proceeding with data entry. These edits will help users submit complete records that meet the basic requirements of the survey edit system used for processing OY Survey data at the Regional Field Offices.

Examples of Edits in CAPI Form B:

- Fieldwork Date must be set before entering any other data in the form
- A Status Code must be selected for each sample
- When Unit Location = 3- Unit Laid out Previously, the row space measurement cells will be hidden (not shown) in CAPI. This is in place because the row space measurement does not change in a sample unit from month to month without first relocating it to a new position in the sample field.
- Maturity code dependent data checks permit data entry only in cells allowed for each maturity code selection
- Enumerator and Supervisor number must be present on all samples

NOTE: These edit checks will not prevent you from entering data incorrectly in CAPI. The system is only in place to help reduce the instance of errors made during data entry. It is not a substitute for reviewing your work and making sure the correct data is entered into CAPI from your paper form. Always review your work in CAPI before data entry and final submission. Please remember errors on the paper form will also be errors when they are keyed into CAPI and loaded to the survey edit system.

CAPI Form A Status Codes

Prior to the implementation of CAPI data collection in the Objective Yield Survey, status codes were determined by the survey statistician based on the data reported by the enumerator who completed the form. The Form A status code is used to identify the sample's Completion status to determine future availability of Form B observations.

A status code must be selected at the beginning Objective Yield form to allow it to be submitted into CAPI. Please read the selections from the drop-down menus carefully before selecting the code that identifies the status of the sample being enumerated.

*****Status codes may differ across all Objective Yield forms for all crops*****

Wheat Form A Status Code Definitions:

1- Complete

First Visit: The enumerator was able to get permission to visit the field, lay out the sample units and complete the Form A.

Minimum data requirement for Status Code 1:

- Interview date must be entered
- Questions 1-5 must be positive where applicable (102-105)
- Enumerator and supervisor number must be entered
- Status Code 1 must be selected (180)

7- Refusal

Any Visit: The farmer refused to participate in the survey in the Form A-1 interview or decided they do not want samples laid out in the field.

Future Visits: No future visits will be required.

Minimum data requirement for Status Code 7:

- Interview date must be entered
- Status Code 7 must be selected (180), no other data is required.
Enumerator and supervisor number must be entered.
Put in Form B and E (if applicable) as refusals as well

13- No Winter Wheat for Harvest as Grain on Entire Farm

First Visit: No wheat was planted for harvest as grain on the entire farm at the time the Form A-1 interview was conducted.

Future Visits: No future visits will be required.

Minimum data requirement for Status Code 13:

- Interview date must be entered
- Status Code 13 must be selected (180), no other data is required
Enumerator and supervisor number must be entered
Put in Form B and E (if applicable) as No Wheat as well

When Wheat Form A Status Code is:	Is Form A Expected Next Month?
1- Complete (Form A expected next visit)	NO
7- Refusal	NO
13- No winter wheat for harvest as grain on entire farm	NO

CAPI Response Coding and Where to Enter Comments

After Form A data entry is completed select the following response codes in the submission screen. See below for comments entry example.

Item	Response Coding Used for OY Surveys
Response:	Completed
Respondent:	(Who Responded)
Respondent Name:	(Leave Empty)
Respondent Mode:	Telephone on iPad
Enumerator:	Auto coded from Assignment Listing
Comments:	General survey comments from the paper form should be entered in the comments icon. Comments that are related to a particular cell or item can be entered in item level comments, accessible via calculator icon.

ENUMERATOR
FORM A 1 WINTER WHEAT YIELD SURVEY

Response:

Respondent:

Responded By (Enter respondent's name, if not the operator):

Reporting Mode:

Enumerator:

PREVIOUS
NEXT

CAPI Form B Status Codes

Prior to the implementation of CAPI data collection in the Objective Yield Survey, status codes were determined by the survey statistician based on the data reported by the enumerator who completed the form.

The status code is used to identify the sample's status for the current enumeration period based upon recorded observations.

A status code must be selected at the end of each Objective Yield form to allow it to be submitted.

Please read the selections from the drop-down menus carefully before selecting the code that identifies the status of the sample being enumerated.

*****Status codes differ across all Objective Yield forms for all crops*****

Wheat Form B Status Code Definitions:

1- Complete (Form B Expected Next Visit)

First Visit: The enumerator was able to visit the field, lay out the sample units and complete the Form B for both units prior to harvest maturity.

Future Visits: The enumerator will return to the sampled field to record measurements for both units and complete Form B accordingly each month until the sample units are mature enough to perform pre-harvest procedures and send the sample to the national laboratory for processing.

Minimum data requirement for Status Code 1:

- Fieldwork date must be entered
- Unit Location Codes must be 1-3 (305, 307)
- Row Space measurement must be empty when: (301, 303)
 - Unit Location Code = 3, Sample unit laid out previously
- Unit 1 & 2 Maturity Codes must be 1-5 (300, 302)
- Questions 7-9a. must be positive where applicable (311-336)
- Enumerator and supervisor number must be entered
- Status Code 1 must be selected (380)

Form B is expected next month

2- Farmer Harvested for Grain Before Unit Was Laid Out

First Visit: The farmer harvested the sampled field for grain before sample units were laid out. Form B will be completed for the first month for this sample.

Future Visits: No future visits will be required.

Minimum data requirement for Status Code 2:

- Fieldwork date must be entered
- Enumerator and supervisor number must be entered
- Status Code 2 must be selected (380), no other data is required
Form B is **not** expected next month.

3- Farmer Harvested for Grain After Units Laid Out

After First Visit: The enumerator was able to complete at least one Form B enumeration in a previous survey month, but the field was harvested prior to the following month's visit for enumeration and/or pre-harvest sample collection.

Future Visits: No future visits will be required.

Minimum data requirement for Status Code 3:

- Fieldwork date must be entered
- Enumerator and supervisor number must be entered
- Status Code 3 must be selected (380), no other data is required
Form B is **not** expected next month.

4- Enumerator Harvested or Both Units Are Blank (No future Form B expected)

Pre-Harvest: When the sampled field is in maturity code 6 or 7. Perform pre-harvest procedures for each sample unit, package, and send the samples to the national laboratory according to specifications outlined in this manual.

Future Visits: No future visits will be required.

Minimum data requirement for Status Code 4 (Pre-Harvest):

- Fieldwork date must be entered
- Unit Location Codes must be 1-3 (301, 303)
- Row Space measurement must be **empty** when: (301, 303)
 - Unit Location Code = 3, Sample unit laid out previously
- Unit 1 & 2 Maturity Codes must be 6 or 7 (300, 302)
- Questions 8-9b. must be positive where applicable (311-344)
- Enumerator and supervisor number must be entered
- Status Code 4 must be selected (380)
Form B is **not** expected next month.

Blank Units: When both units fall in blank areas there is no wheat available to measure for the survey. Submit Form B data with the minimum data requirements noted below.

Future Visits: No future visits will be required.

Minimum data requirement for Status Code 4 (Both Units Blank):

- Fieldwork date must be entered
- Unit Location Codes must be 1-3 (301, 303)
- Row Space measurement must be **888.8** for both units (301, 303)
- Unit 1 & 2 Maturity Codes must be 8 (300, 302)
- Enumerator and supervisor number must be entered
- Status Code 4 must be selected (380)
Form B is **not** expected next month.

5- Field Partially Destroyed and Both Units Destroyed

Any Visit: The sampled field and/or both sample units have been destroyed to the point where the field can no longer be harvested for grain. This situation commonly occurs in instances where the sampled field has incurred severe damage from weather (wind, hail, etc.), fire, vandalism, etc.

Future Visits: No future visits will be required.

Minimum data requirement for Status Code 5:

- Status Code 5 must be selected (380), no other data is required.
Form B is **not** expected next month.
Enumerator and supervisor number must be entered.

6- Lost Sample – Field Not Harvested for Grain

Any Visit: The sampled field will not be harvested for grain. The field will be used for purposes other than grain (grazing, silage/other forage, hay, abandoned, etc.).

Future Visits: No future visits will be required.

Minimum data requirement for Status Code 6:

- Status Code 6 must be selected (380), no other data is required.
Form B is **not** expected next month.
Enumerator and supervisor number must be entered.

7- Refusal

Any Visit: The farmer refused to participate in the survey in the Form A-1 interview or decided they no longer wished to participate after samples were laid out in the field.

Future Visits: No future visits will be required.

Minimum data requirement for Status Code 7:

- Status Code 7 must be selected (380), no other data is required.
Form B is **not** expected next month.
Enumerator and supervisor number must be entered.

8- Inaccessible (Form B Expected Next Visit)

Any Visit: The sampled field was inaccessible for the current survey period. This occurs in instances where enumeration for the survey month was prohibited by weather, field point of access was closed, locked, recent chemical applications, etc.

Future Visits: Return to field as normally scheduled.

Minimum data requirement for Status Code 8:

- Status Code 8 must be selected (380), no other data is required
Form B is expected next month.
Enumerator and supervisor number must be entered

13- No Winter Wheat for Harvest as Grain on Entire Farm

First Visit: No wheat was planted for harvest as grain on the entire farm at the time the Form A-1 interview was conducted.

Future Visits: No future visits will be required.

Minimum data requirement for Status Code 13:

- Status Code 13 must be selected (380), no other data is required
Form B is **not** expected next month.
Enumerator and supervisor number must be entered

When Wheat Form B Status Code is:	Is Form B Expected Next Month?
1- Complete (Form B expected next visit)	YES
2- Farmer harvested for grain before unit was laid out	NO
3- Farmer harvested for grain after units laid out	NO
4- Enumerator harvested or Both units are blank	NO
5- Field partially destroyed and both units destroyed	NO
6- Lost Sample – Field NOT harvested for grain	NO
7- Refusal	NO
8- Inaccessible (Form B expected next visit)	YES
13- No winter wheat for harvest as grain on entire farm	NO

CAPI Response Coding and Where to Enter Comments

After Form B data entry is completed select the following response codes in the submission screen for each record.

Item	Response Coding Used for OY Surveys
Response:	Completed
Respondent:	Other
Respondent Name:	(Leave Empty)
Respondent Mode:	Face-to-Face on iPad
Enumerator:	Auto coded from Assignment Listing
Comments:	General survey comments from the paper form should be entered in the comment's icon located under the comment bubble icon (circled below). Comments that are related to a particular cell or item can be entered in item level comments, accessible via calculator icon.

8:41 AM Mon Jan 13 85%

United States Department of Agriculture
 National Agricultural Statistics Service

Help ?

ENUMERATOR FORM B WHEAT YIELD COUNTS - WINTER WHEAT OY-JUNE

Response:

Respondent:

Responded By (Enter respondent's name, if not the operator):

Respondent Mode:

Enumerator:

DOE FARMS INC
JOHN DOE
08 100143670 SEQ:78

Please click the Save button after typing in your comments.